

Appendix A11.8: Watercourse Crossings Report

1 Introduction

- 1.1.1 This Appendix provides additional information relating to watercourse crossings to be constructed or modified as part of the proposed scheme.
- **Section 2** provides a general description of the outline design approach being adopted.
 - **Section 3** considers each watercourse crossing in turn identifying the preferred approach that has been adopted at this stage in the proposed scheme development.
 - **Section 4** provides photographs of the existing watercourse crossings.
 - **Section 5** provides a schematic plan and long section for each proposed watercourse crossing.
- 1.1.2 This report considers the watercourse crossings associated with the proposed scheme at 'Design Fix 8', dated February 2018 and is to be read in conjunction with the relevant sections of the Environmental Statement and in particular Chapter 11 (Road Drainage and the Water Environment).

2 Outline Design Approach

- 2.1.1 At each proposed watercourse crossing, consideration has been given to the nature and size of the crossing, and environmental requirements. These crossings range in style including simply supported beam bridges, arch bridges and box/circular culverts.
- 2.1.2 At each watercourse crossing, consideration has been given to the 'opening size' of the bridge/culvert required to pass the design fluvial event¹ incorporating appropriate freeboard. This also includes consideration of the impact of the proposed watercourse crossing on flood risk, associated with the design flood event.² This is reported in greater detail in Appendix A11.3 (Flood Risk Assessment) of the Environmental Statement.
- 2.1.3 The outline design approach adopted for each of the watercourse crossings is provided below. In addition, reference is to be made to the outline design approach adopted to develop the larger bridge crossings i.e. non culvert crossings (3 of which exist within the proposed scheme) as identified in Section 3 of this appendix.

Culvert Watercourse Crossings

- 2.1.4 The majority of the watercourses crossed by the existing A9 are conveyed by means of a culvert. The proposed scheme retains the same general approach to these watercourse crossings by following the design process defined below.
- 2.1.5 The decision making hierarchy adopted with regards to the general approach being adopted at each watercourse crossing is presented below in order of preference:
- Retain the existing watercourse crossing infrastructure unchanged.
 - Retain the existing watercourse crossing infrastructure, but extended to accommodate the proposed scheme.
 - Replace the existing watercourse crossing infrastructure with new infrastructure.

¹ The 'design fluvial event' is used to define the fluvial event used in the design of watercourse crossings and the magnitude of the event will be stated as appropriate.

² The 'design flood event' is the estimated peak flow associated with the 0.5% Annual Exceedance Probability (AEP) (200-year) plus an allowance for climate change flood event.

- 2.1.6 In terms of flood risk, all proposed watercourse crossings have been assessed against the design flood event i.e. 0.5% AEP (200-year) plus an allowance for long term sustainability and resilience (e.g. an allowance for climate change and a minimum of 600mm freeboard to proposed road level) such that the proposed scheme remains operational and safe for users during times of flood and flood risk is not compromised elsewhere, as reported in Appendix A11.3 (Flood Risk Assessment).
- 2.1.7 Additionally, and where existing flood risk is not compromised, all new replacement watercourse crossings (i.e. where it is proposed that an existing culvert is fully removed and replaced with a new culvert) have been sized as a minimum to freely pass the peak flow associated with the predicted 0.5% AEP (200-year) design fluvial event with appropriate freeboard within the culvert barrel. Culvert freeboard for culverts up to 1.2m diameter is one quarter of the pipe diameter, whereas for larger culverts freeboard is in the range of 200mm to 500mm, as suggested in CIRIA C689 'Culvert design and operation guide'.

Cascades

- 2.1.8 There are a number of locations where the proposed scheme will result in an earthwork 'cut' into the adjacent hillside or the invert of the new watercourse crossing will be lowered to pass beneath the proposed road drainage system. In both cases this will result in a steepened watercourse requiring a 'cascade' to safely convey the design flood event without compromising the integrity of the hillside and/or operation of the proposed scheme.
- 2.1.9 From a hydraulic perspective, the flow of water within a cascade is complex and characterised by two different flow types – 'nappe flow' and 'skimming flow'. 'Nappe flow' is characterised by a succession of free falling drops at each step with water depth recovering before the next step. 'Skimming flow' occurs when each step is submerged, typically occurring during larger magnitude discharges and/or longer cascades and requiring a stilling basin at the toe of the cascade to dissipate energy and allow water depth recovery. Both flow types are acceptable, as long as the proposed cascade geometry safely contains the flow of water.
- 2.1.10 The design approach taken has been to design a hydraulic cascade to typically follow the proposed hillside topography, without significant additional excavation to form the cascade steps, which typically will have a head drop no greater than 0.5m, subject to further development at both specimen and detail design stage. This 0.5m would represent the height above the pool surface and not the depth of any pool associated with the cascade.
- 2.1.11 Where a cascade is considered necessary at each watercourse, this is identified in Section 3 and also shown schematically on the drawings. The nature of the cascade dependent upon a number of factors but in general may take one of the following forms:
- bedrock channel cascade;
 - natural cascade with natural gravel, cobbles and rock forming individual steps; and
 - concrete cascade with stone pitching.
- 2.1.12 The geometry and form of each cascade will be considered on a case by case basis at specimen design stage taking into account hydraulic requirements, topography, fluvial morphology and nature of the underlying strata and its susceptibility to fluvial erosion (if known). As such, the geometry of the proposed cascades provided in this report and associated drawings is indicative and will be subject to further development at both specimen and detail design stage.

Scour Protection Measures

- 2.1.13 Fluvial scour of highway structure foundations is a major cause of failure; hence attention should be given to the design of new watercourse crossings to prevent failure due to fluvial scour.
- 2.1.14 For each proposed watercourse crossing an assessment has been made regarding the need to offer energy dissipation / scour protection measures, in particular at bridge abutments, bridge piers, culvert exits and/or any other river training works required as part of the proposed scheme.

- 2.1.15 Where highway structures are founded directly onto sound bedrock and/or the watercourse local to the structure is formed by a bedrock channel with little or no alluvium mantling the risk of scour is considered to be 'low' and hence no additional scour protection measures are likely.
- 2.1.16 Where highway structures are not founded directly onto sound bedrock and/or the channel local to the structure is not formed of bedrock, consideration has been given to estimating the maximum depth of scour such that structure foundations are set below this level and/or scour protection measures are provided to offer protection against scour and possible undermining of the structure foundations.
- 2.1.17 The zone of scour influence for each watercourse is provided in Section 3 and also shown on the associated drawings. The need and if required the nature of any scour protection measures and/or energy dissipation features will be determined at specimen design stage, taking into account the vulnerability of the protected asset, hydraulic requirements, channel morphology and nature of the underlying strata (if known).
- 2.1.18 The design of any scour protection measure and/or energy dissipation feature will be in accordance with the relevant provision of the DMRB BD97/12 (The Highways Agency et al. 2012).

Environmental Design

- 2.1.19 In so far as practicable, all river engineering works associated with the scheme will be in accordance with Scottish Environmental Protection Agency (SEPA) good practice guidance, particularly with respect to river crossings (SEPA and Natural Scotland, 2010), sediment management (SEPA, 2010) and bank protection (SEPA, 2008). Where this is not possible further justification will be provided at specimen design stage.
- 2.1.20 Particular consideration has been given in this report to the provision of mammal and fish passage, and burying the culvert invert with natural riparian river deposits.

Mammal Passage

- 2.1.21 The provision of mammal passage within new watercourse crossings has been considered alongside geometric constraints, hydraulic performance requirements and other aspects of scheme design in developing the watercourse crossing proposals outlined in this report.
- 2.1.22 Where existing watercourse crossings are being replaced with a new culvert, consideration has been given to provide integral mammal passage where an ecological need has been identified. Mammal ledges have been designed in accordance with DMRB HA81/99 (The Highways Agency et al. 2001).
- 2.1.23 Where an existing watercourse crossing culvert has been confirmed to provide a mammal corridor but is being retained and extended to accommodate the proposed scheme, it is proposed to provide an adjacent dry mammal underpass to maintain and/or improve habitat connectivity.
- 2.1.24 The provision of mammal passage by means of dry mammal underpass rather than provision of mammal ledges within an enlarged watercourse culvert has been selected to avoid the need to significantly enlarge the culvert cross-section in order to meet DMRB requirements. Locations of dry mammal underpasses are detailed on Figure 13.5 of the ES.
- 2.1.25 Consequently, the use of dry mammal underpasses in such a situation reduces the need to increase clearance between the proposed scheme road level and the watercourse river bed level. Raising the proposed scheme road level may have significant impacts in terms of increasing the footprint of the road, drainage design, visual impact and increased capital cost; whereas the alternative option of lowering the watercourse potentially requires significant engineering intervention in the river channel, with possible further ecological and geomorphological impacts. Avoiding, or minimising an increase in culvert size also has the benefit of minimising the impact on the existing hydraulic regime and flood risk.
- 2.1.26 Where required details relating to the provision of mammal passage within culvert structures are provided in Section 3 and are also shown on the drawings. Dry mammal underpasses are not detailed

within this report, but their presence is noted in Section 3 (Watercourse Crossing Information) where the dry mammal underpass is associated with an adjacent watercourse.

- 2.1.27 No provision is made for mammal passage through culverts proposed as part of the proposed scheme to accommodate access tracks, non-motorised user tracks and other minor crossings. Due to the (infrequent, low speed and/or non-motorised user) nature of the traffic using such minor crossings the risk to mammals crossing overland in times of high river flow within the culvert barrel is not considered to be significant.

Fish Passage

- 2.1.28 The current accessibility of each watercourse for migratory fish is provided in Appendix A11.1 (Baseline Conditions), where data has been available.
- 2.1.29 In line with good practice guidance (SEPA and Natural Scotland 2010), measures to provide fish passage will be developed for each watercourse crossing, as determined where necessary through consultation with SEPA and the Tay District Salmon Fisheries Board, at both the specimen and detailed design stage for applications made under The Water Environment (Controlled Activities) (Scotland) Regulations 2011 (as amended).

Buried Culvert Invert

- 2.1.30 Where possible consideration has been given to burying the culvert invert below the natural river bed level to allow for a naturalised culvert bed. This approach has been taken where a new culvert is proposed of moderate gradient and generally where the natural river bed level and bed slope is maintained through the culvert.
- 2.1.31 Where this is not the case, in particular where the channel upstream is relatively steep and the natural retention of sediment is not expected, where the design incorporates a hydraulic feature such as a cascade formed by either a concrete channel or natural bedrock channel and/or where the existing culvert is being retained and extended, culvert embedment may not be appropriate or sustainable. The requirement for providing a buried culvert invert will be considered at each culvert location and where necessary developed further at specimen and detailed design.
- 2.1.32 The depth of natural river bed material above the culvert invert will vary depending on the size of culvert and also hydraulic requirements. Typically, the depth of natural material will meet the following criteria, as suggested in 'River Crossings (Engineering in the water environment: a good practice guide)', (SEPA and Natural Scotland, 2010) and where necessary baffles and step pools may be included to aid retention of river bed deposits:
- for culverts less than 1.2m diameter, the invert should be buried at least 150mm below natural bed level;
 - for culverts between 1.2 and 1.8m diameter, the invert should be buried at least 200mm below natural bed level; and
 - for culverts greater than 1.8m diameter, the invert should be buried at least 300mm below natural bed level.
- 2.1.33 In addition, and where possible, all new proposed scheme culverts should maintain the existing natural channel width.
- 2.1.34 The depth of embedment at each watercourse crossing is provided in Section 3 and also shown on the associated drawings.

3 Watercourse Crossing Information

- 3.1.1 Table 1 provides information for each watercourse crossing which could be affected by the proposed scheme. This includes identification of the waterbody affected (together with predicted flood flows at the point of interest), details of the proposed works and broad justification for the engineering solution.

- 3.1.2 Cross-reference should be made between Table 1 and Sections 4 and 5, which provide photographs of the existing watercourse crossing and outline drawing of the proposed scheme watercourse crossing respectively.

Table 1: Watercourse Crossings additional information

| Waterbody | Culvert number & Location | Construction detail | Justifications for engineering solution |
|--|--|---|---|
| <p>WF16</p> <p>Approximate channel bed width at mainline culvert inlet: 1.3m</p> <p>Flow data: 50% AEP: 0.57m³/s 1% AEP: 0.76m³/s 0.5% AEP + CC: 1.06m³/s</p> | <p>16/A9</p> <p>Grid Reference: (300552, 744245)</p> | <p>Replacement of existing A9 culvert with new culvert, including gradient change via manhole on road verge.</p> <p>New cascade feature to lower upstream watercourse to new culvert entrance invert level and local realigning of the channel downstream of the culvert outlet.</p> <p>Existing diameter = 1.1m Existing length = 43.8m</p> <p>Proposed diameter = 1.2m Proposed length = 58.2m Proposed embedment = 0.2m</p> | <p>Watercourse WF16 is culverted beneath the existing A9 via a 1.1m diameter concrete culvert. The existing culvert inlet is set back from the carriageway close to existing and proposed A9 road levels.</p> <p>The proposed scheme will result in the A9 footprint at this location being widened on both the upstream and downstream sides to accommodate the scheme. The proposed widening on the downstream side (northbound carriageway) is included within Project 3, whereas the upstream (southbound carriageway) widening is included within Project 2. Additionally, a new road drainage treatment basin on the downstream side clashes with the location of the existing culvert outlet.</p> <p>To accommodate the proposed scheme, a number of alternative watercourse crossing options have been considered, as follows:</p> <ul style="list-style-type: none"> Retain the existing culvert unchanged: The existing culvert is not long enough to accommodate the proposed scheme. Extension of the existing culvert: The existing culvert could be extended to accommodate the footprint of the proposed scheme, however this will not resolve the conflicts between the culvert infrastructure and proposed scheme road and drainage levels. Resolving the level conflicts will require elevating the proposed scheme road and drainage level to accommodate the existing culvert infrastructure and moving the drainage pond. This will have a significant impact in terms of increasing the footprint of the road, drainage design, visual impact, and also contribute to increased capital cost. Replace the existing culvert: This is the preferred option: that the culvert will be replaced to a new alignment and lower gradient to accommodate the proposed scheme. <p>Proposed Scheme</p> <p>The preferred solution for this crossing, taking account of engineering and environmental design criteria, is to replace the existing culvert with a new culvert to accommodate the proposed scheme.</p> <p>The new culvert replaces the existing culvert on a new plan alignment with a new culvert inlet location at a lower level than the existing. This will require the culvert invert level at its inlet to be set at a lower level than the present channel bed level at this location. In addition, the channel gradient immediately upstream of the culvert entrance will be steeper; hence a new cascade feature will be required to convey the flow of water to the culvert entrance. A new culvert exit is proposed to the north of the new drainage basin. The proposed new culvert will have a larger internal diameter and will have a change in gradient at a manhole, located in the northbound verge to convey flow beneath the proposed scheme infrastructure to the outlet location. It is recognised that having a change in gradient mid culvert is not preferable, however this approach minimises the steepness and depth of the required upstream cascade.</p> <p>Realignment of the upstream channel is required locally at the top of the earthwork 'cut' to meet the cascade entrance. Downstream, channel realigning is required to tie into the existing watercourse.</p> <p>Environmental</p> <p>Ecological assessment has not identified this watercourse as a mammal corridor; hence the provision for mammal passage is not required.</p> <p>The invert of the new culvert will be buried to maintain continuity of the culvert invert gradient and natural bed material.</p> |

| Waterbody | Culvert number & Location | Construction detail | Justifications for engineering solution |
|--|--|--|---|
| | | | <p>Flood Risk</p> <p>The existing culvert freely passes the peak flow associated with the design flood event i.e. 0.5%AEP (200-year) plus an allowance for climate change, however peak water levels upstream are predicted to be out of bank under the design flood event. Freeboard to the existing A9 road level is 0.6m, consequently the existing A9 is not considered to be at flood risk during the design flood event.</p> <p>The new culvert arrangement will also freely pass the design flood event, with 0.35m culvert freeboard during the 0.5% AEP (200-year) design fluvial event. The head water depth at the culvert entrance is predicted to increase by 0.025m as a result of lengthening of the culvert.</p> <p>The available flood freeboard between headwater level and the proposed A9 road level is 1.76m, hence the proposed scheme is not considered to be at flood risk during design flood event. The head water level is out of bank in the upstream channel however, as there are no sensitive receptors in the upstream reach no further mitigation measures are considered necessary.</p> <p>Downstream flood risk associated with the design flood event is not impacted by the proposed scheme.</p> |
| <p>WF18</p> <p>Approximate channel bed width at mainline culvert inlet: 1.8m</p> <p>Flow data: 50% AEP: 0.55m³/s 1% AEP: 0.71m³/s 0.5% AEP + CC: 0.99m³/s</p> | <p>18/A9</p> <p>Grid Reference: (311945, 745046)</p> | <p>Replace existing A9 culvert with new box culvert.</p> <p>New cascade feature to lower upstream watercourse to new culvert entrance invert level.</p> <p>Existing diameter = 0.77m Existing length = 75.5m</p> <p>Proposed height = 1.5m Proposed width = 1.8m Proposed length = 55.9m Proposed embedment = 0m</p> | <p>Watercourse WF18 is culverted beneath the existing A9 via a 0.77m diameter concrete culvert. The existing culvert inlet is set back from the carriageway at the top of an existing embankment. The embankment is set at a steeper gradient than a straight alignment between the inlet and outlet meaning the gradient of the culvert must change at an unknown location.</p> <p>The proposed scheme will result in the A9 footprint at this location being widened on the upstream side (southbound carriageway) to accommodate the scheme and new adjacent side road.</p> <p>To accommodate the proposed scheme, a number of alternative watercourse crossing options have been considered, as follows:</p> <ul style="list-style-type: none"> • Retain the existing culvert unchanged: The existing culvert is long enough to accommodate the proposed scheme, however, the existing culvert infrastructure conflicts with proposed road and drainage levels and proposed re-profiling of the existing embankment. • Extension of the existing culvert: The existing culvert is long enough to accommodate the footprint of the proposed scheme; however, this will not resolve the conflicts between culvert infrastructure and proposed scheme levels and excavation. Resolving these conflicts will require elevating the proposed scheme road and drainage levels to accommodate the existing culvert infrastructure. This will have a significant impact in terms of increasing the footprint of the road, drainage design, visual impact, and also contribute to increased capital cost. • Replace the existing culvert: This is the preferred option: that the culvert will be replaced to a new alignment and lower gradient to accommodate the proposed scheme. <p>Proposed Scheme</p> <p>The preferred solution for this crossing, taking account of engineering and environmental design criteria, is to replace the existing culvert at a revised alignment to accommodate the proposed scheme.</p> <p>The new box culvert replaces the existing culvert on the same plan alignment with the culvert outlet location being retained,</p> |

| Waterbody | Culvert number & Location | Construction detail | Justifications for engineering solution |
|--|--|---|--|
| | | | <p>at a lower invert level than the present river bed level.</p> <p>The proposed scheme will require an earthwork 'cut' into the adjacent hillside to win space to accommodate the new southbound carriageway. A new culvert inlet is proposed at the edge of the upstream road verge thereby reducing the length of culvert required. This will require the culvert invert level at its inlet to be set at a lower level than the present channel bed level at this location. In addition, the channel gradient immediately upstream of the culvert entrance will be steeper; hence a new cascade feature will be required to convey the flow of water to the culvert entrance. Realignment of the upstream channel is required locally at the top of the earthwork 'cut' to meet the cascade entrance.</p> <p>Downstream, channel regrading is required to tie into the existing watercourse.</p> <p>Environmental</p> <p>Ecological assessment has identified this watercourse as being an active mammal corridor and consequently there is a requirement to provide mammal passage. To facilitate this, a box culvert is proposed, with mammal ledges set at the appropriate level.</p> <p>The invert of the new culvert will be buried to maintain continuity of the culvert invert gradient and natural bed material.</p> <p>Flood Risk</p> <p>The existing culvert is surcharged during the design flood event i.e. 0.5%AEP (200-year) plus an allowance for climate change. The water level at the culvert inlet is predicted to surcharge the culvert soffit by 0.26m, although peak water level is predicted to be contained within the river banks of the upstream channel. The existing A9 is therefore not considered to be at flood risk during the design flood event, with 1.91m existing freeboard available.</p> <p>The new culvert arrangement will freely pass the design flood event, with 0.78m culvert freeboard during the 0.5% AEP (200-year) design fluvial event. The head water depth at the culvert entrance is predicted to decrease by 0.47m as a result of upsizing of the culvert to allow for mammal passage.</p> <p>The available freeboard between headwater level and the proposed A9 road level is 2.02m, hence the proposed scheme is not considered to be at flood risk during design flood event. As the head water level is contained within the upstream channel, no further mitigation measures are considered necessary.</p> <p>Downstream flood risk is impacted by the proposed scheme, as the larger culvert barrel no longer throttles the design flow upstream. However, the increase in peak flow at WF18 is considered negligible compared to peak flow in the River Tay located immediately downstream, as such, no mitigation measures are considered necessary.</p> |
| <p>WF19</p> <p>Approximate channel bed width at mainline culvert inlet: 1.1m</p> <p>Flow data: 50% AEP: 0.34m³/s 1% AEP: 0.43m³/s 0.5% AEP + CC:</p> | <p>19/A9</p> <p>Grid Reference: (299159, 742571)</p> | <p>Replace the existing A9 culvert with new box culvert.</p> <p>New cascade feature to lower upstream watercourse to new culvert entrance invert level.</p> <p>Existing diameter = 1.10m Existing length = 47.1m</p> | <p>Watercourse WF19 is culverted beneath the existing A9 via a 1.10 m diameter concrete culvert. The existing culvert inlet is set back from the carriageway close to existing and proposed A9 road level.</p> <p>The proposed scheme will result in the A9 footprint at this location being widened on the upstream side (southbound carriageway) to accommodate the scheme and new adjacent side road.</p> <p>To accommodate the proposed scheme, a number of alternative watercourse crossing options have been considered, as follows:</p> <ul style="list-style-type: none"> • Retain the existing culvert unchanged: The existing culvert is not long enough to accommodate the proposed scheme. • Extension of the existing culvert: The existing culvert can be extended to accommodate the footprint of the proposed scheme, however this will not resolve the conflicts between the existing culvert infrastructure and proposed scheme road and drainage level. |

| Waterbody | Culvert number & Location | Construction detail | Justifications for engineering solution |
|--|--|---|--|
| 0.61m ³ /s | | Proposed height = 1.2m Proposed width = 1.5m Proposed length = 72.1m Proposed embedment = 0m | <p>Resolving the level conflicts will require elevating the proposed scheme road and drainage level to accommodate the existing culvert infrastructure. This will have a significant impact in terms of increasing the footprint of the road, drainage design, visual impact, and also contribute to increased capital cost.</p> <ul style="list-style-type: none"> Replace the existing culvert: This is the preferred option: that the culvert will be replaced to a new lower alignment to accommodate the proposed scheme. <p>Proposed Scheme</p> <p>The preferred solution for this crossing, taking account of engineering and environmental design criteria, is to replace the existing culvert at a revised alignment to accommodate the proposed scheme.</p> <p>The new box culvert replaces the existing culvert on the same plan alignment with new culvert inlet and outlet locations to accommodate the widened footprint of the proposed scheme. The culvert invert level at its inlet will be set at a lower level relative to the existing river bed level.</p> <p>The proposed scheme will require an earthwork 'cut' into the adjacent hillside to win space to accommodate the new southbound carriageway. In addition, the channel gradient immediately upstream of the culvert entrance will be steeper; hence a new cascade feature will be required to convey the flow of water to the culvert entrance. The proposed typical geometry of the cascade is shown on the drawing (Section 5) and the nature of the cascade will be further developed at specimen and detail design stage, but will likely be either a bedrock cascade, natural cascade or concrete (stone pitched) cascade.</p> <p>Environmental</p> <p>Ecological assessment has identified this watercourse as being an active mammal corridor and consequently there is a requirement to provide mammal passage. To facilitate this, a box culvert will be provided with mammal ledges set at the appropriate level.</p> <p>The invert of the new culvert will be buried to maintain continuity of the culvert invert gradient and natural bed material.</p> <p>Flood Risk</p> <p>The existing culvert freely passes the design flood event i.e. 0.5%AEP (200-year) plus an allowance for climate change. To pose risk to the A9, headwater levels require to overtop the inlet headwall. Under baseline conditions with the existing culvert there is 0.76m freeboard from the headwater level to the spill level. Consequently, the existing A9 is not considered to be at flood risk during the design flood event.</p> <p>The new culvert arrangement will also freely pass the design flood event, with 0.74m culvert freeboard during the 0.5% AEP (200-year) design fluvial event. The head water depth at the culvert entrance is predicted to decrease by 0.03m as a result of upsizing of the culvert to allow for mammal passage. The available freeboard between headwater level and the proposed A9 road level is 2.06m, hence the proposed scheme is not considered to be at flood risk during design flood event.</p> <p>Downstream flood risk is not impacted by the proposed scheme.</p> |
| WF20 Approximate channel bed width at mainline culvert inlet: 1.1m | 20/A9 Grid Reference: (300591, 740785) | Replace existing A9 culvert with a new box culvert. New cascade feature to lower upstream watercourse to new | Watercourse WF20 is culverted beneath the existing A9 via a 1.10m diameter concrete culvert. The proposed scheme will result in the A9 footprint at this location being widened on both the upstream and downstream side to accommodate the scheme and new junction slip road. To accommodate the proposed scheme, a number of alternative watercourse crossing options have been considered, as follows: |

| Waterbody | Culvert number & Location | Construction detail | Justifications for engineering solution |
|---|---------------------------|--|--|
| <p>Flow data: 50% AEP: 0.49m³/s 1% AEP: 0.62m³/s 0.5% AEP + CC: 0.90m³/s</p> | | <p>culvert entrance invert level.</p> <p>Existing diameter = 1.10m Existing length = 51.0m</p> <p>Proposed height = 1.5m Proposed width = 1.5m Proposed length = 54.6m Proposed embedment = 0m</p> | <ul style="list-style-type: none"> Retain the existing culvert unchanged: The existing culvert is long enough to accommodate the proposed scheme, however, the existing culvert infrastructure conflicts with proposed scheme road and drainage levels. Extension of the existing culvert: The existing culvert infrastructure conflicts with the proposed scheme road and drainage levels. Resolving the level conflicts will require elevating the proposed scheme road surface and drainage level to accommodate the existing culvert infrastructure. This will have a significant impact in terms of increasing the footprint of the road, drainage design, visual impact and also contribute to increased capital cost. Replace the existing culvert: This is the preferred option: that the culvert will be replaced to a new lower alignment to accommodate the proposed scheme. <p>Proposed Scheme</p> <p>The preferred solution for this crossing, taking account of engineering and environmental design criteria, is to replace the existing culvert at a revised alignment to accommodate the proposed scheme.</p> <p>The new box culvert replaces the existing culvert on the same plan alignment with the culvert outlet location being maintained, albeit at a lower invert level than the existing river bed level.</p> <p>The proposed scheme will require an earthwork 'cut' into the adjacent hillside to win space to accommodate the new southbound carriageway. In addition, the channel gradient immediately upstream of the culvert entrance will be steeper; hence a new cascade feature will be required to convey the flow of water to the culvert entrance. The proposed typical geometry of the cascade is shown on the drawing (Section 5) and the nature of the cascade will be further developed at specimen and detail design stage, but will likely be either a bedrock cascade, natural cascade or concrete (stone pitched) cascade.</p> <p>Environmental</p> <p>Ecological assessment has identified this watercourse as being an active mammal corridor and consequently there is a requirement to provide mammal passage. To facilitate this, a box culvert will be provided with mammal ledges set at the appropriate level.</p> <p>The invert of the new culvert will be buried to maintain continuity of the culvert invert gradient and natural bed material.</p> <p>Flood Risk</p> <p>The existing culvert is surcharged during the design flood event i.e. 0.5%AEP (200-year) plus an allowance for climate change. The water level at the culvert inlet surcharges the culvert soffit by 0.11m, although the peak water level is contained within the banks of the upstream channel. Freeboard to the existing A9 road level is 0.51m.</p> <p>The new culvert arrangement will freely pass the design flood event with 0.69m culvert freeboard during the 0.5% AEP (200-year) design fluvial event. The head water depth at the culvert entrance is predicted to decrease by 0.115m as a result of upsizing of the culvert to allow for mammal passage. The available freeboard between headwater level and the proposed A9 road level is 1.47m, hence the proposed scheme is not considered to be at flood risk during design flood event. As the head water level is contained within the upstream channel, no further mitigation measures are considered necessary.</p> <p>Downstream flood risk is impacted by the proposed scheme, as the larger opening at the inlet headwall no longer throttles the design flow upstream. However, the 0.56m³/s increase in peak flow at WF20 is considered negligible compared to peak</p> |

| Waterbody | Culvert number & Location | Construction detail | Justifications for engineering solution |
|---|---|--|---|
| | | | flow in the River Tay located immediately downstream, as such, no mitigation measures are considered necessary. |
| | 20/DS (side road culvert) Grid Reference: (300591, 740785) | Replace existing A9 culvert with a new box culvert. Existing diameter = 0.3m Existing length = 17.5m Proposed height = 0.8m Proposed width = 1.5m Proposed length = 12.6m Proposed embedment = 0m | A new culvert is required downstream of the A9 crossing to accommodate a proposed side road to the West of the A9 providing access to property and a new drainage pond. The existing watercourse crossing at this location is unsuitable due to the higher elevation of the proposed track. No provision for mammal access is provided within the new culvert due to the infrequent nature of traffic using the access track. The invert of the new culvert will be buried to maintain continuity of the culvert invert gradient and natural bed material. The proposed new box culvert has been designed to pass the 0.5% AEP (200-year) design flood event with appropriate freeboard due to its proximity to the mainline culvert. |
| WF21 Approximate channel bed width at mainline culvert inlet: 0.7m Flow data: 50% AEP: 0.28m ³ /s 1% AEP: 0.35m ³ /s 0.5% AEP + CC: 0.50m ³ /s Note - Flows are quoted for baseline conditions (i.e. excluding the proposed upstream diversion of WF22 into this watercourse) | 21/A9 Grid Reference: 300447, 745354 | Replace existing culvert with diversion to WF23 North of existing inlet location. Existing diameter = N/A Existing length = N/A Proposed diameter = 1.05m Proposed length = 218.3m Proposed embedment = 0.15m | Watercourse WF21 is culverted along the verge of the existing A9 via a concrete pipe of unknown diameter, into an existing manhole adjacent to the A9. It is assumed that flow is then transferred into the existing road drainage, as no downstream outlet has been found and there does not appear to be any connection with adjacent watercourses. The proposed scheme will result in the A9 footprint at this location being widened to both sides of the carriageway. To accommodate the proposed scheme, a number of alternative watercourse crossing options have been considered, as follows: <ul style="list-style-type: none"> • Retain the existing culvert unchanged: The existing culvert does not appear to cross the A9. • Extension of the existing culvert: The existing culvert does not appear to cross the A9; therefore, extension of this culvert would not accommodate the proposed scheme. • Replace the existing culvert: The area downstream of the existing inlet is not suitable to outlet upon, due to environmental concerns. • Divert watercourse to alternate crossing: This is the preferred option: that the watercourse will be diverted to an adjacent watercourse crossing to accommodate the proposed scheme. <p>Proposed Scheme</p> <p>The preferred solution for this crossing, taking account of engineering and environmental design criteria, is to remove the existing culvert and divert flows, via a new pipe to an adjacent watercourse crossing at WF23.</p> <p>The proposed scheme will require an earthwork 'cut' into the adjacent hillside to win space to accommodate the new southbound carriageway.</p> <p>The new diversion will have a new culvert inlet, located at the top of the new embankment immediately downstream of the confluence of WF21 and WF22. The new diversion will carry the combined flow beneath the southbound verge to WF23,</p> |

| Waterbody | Culvert number & Location | Construction detail | Justifications for engineering solution |
|--|---|--|--|
| | | | <p>with the change in gradient and direction achieved via a manhole at the toe of the embankment.</p> <p>The new diversion will discharge directly into the proposed new box culvert at WF23, through the side wall of the culvert, immediately downstream of the proposed WF23 inlet location.</p> <p>Environmental</p> <p>Ecological assessment has not identified this watercourse as a mammal corridor; hence the provision for mammal passage is not required.</p> <p>The area directly to the west of the existing culvert inlet location is noted to be a Special Area of Conservation, as such construction of a new outlet structure and outlet channel at this location is considered to be undesirable.</p> <p>The new diversion pipe invert will be buried to maintain continuity of the culvert invert gradient and natural bed material.</p> <p>Flood Risk</p> <p>The existing flood risk is not known, as it is assumed that the channel drains into the existing A9 road drainage.</p> <p>The new diversion culvert will freely pass the design flood event with 0.25m culvert freeboard during the 0.5% AEP (200-year) design fluvial event. The proposed culvert inlet will be set above the proposed A9 road level, at the top of the earthwork 'cut'. The design flood event is predicted to be contained within the upstream channels, hence the proposed scheme is not considered to be at flood risk during design flood event.</p> <p>As the head water level is contained within the upstream channel, no further mitigation measures are considered necessary.</p> <p>As the diversion does not cross the A9, downstream flood risk on WF21 is not impacted by the proposed scheme, however, diverting flow to WF23 will result in an increase in flood risk to a very short reach of the WF23 i.e. 20m, prior to its confluence with the River Tay.</p> |
| <p>WF22</p> <p>Approximate channel bed width at mainline culvert inlet: 0.5m</p> <p>Flow data: 50% AEP: 0.15m³/s 1% AEP: 0.19m³/s 0.5% AEP + CC: 0.26m³/s</p> | <p>N/A</p> <p>Grid Reference: 300443, 745409</p> | <p>New diversion of the watercourse to its confluence with WF 21 upstream of A9.</p> | <p>Watercourse WF22 currently conveys flow along a drainage channel to its confluence with WF21 and passes into the undetermined WF21 culvert.</p> <p>The proposed scheme will require an earthwork 'cut' into the adjacent hillside to win space to accommodate the new southbound carriageway. The proposed scheme will conflict with the existing channel and confluence of watercourses.</p> <p>Proposed Scheme</p> <p>The preferred approach for WF22 taking account of engineering and environmental design criteria is to realign the existing drainage channel over approximately 21m. The new channel will divert flow from approximately 6m upstream of the existing confluence location to a new confluence with WF21, upstream of the new inlet to the WF21 diversion.</p> <p>Environmental</p> <p>No change to the local watercourse is proposed.</p> <p>Flood risk</p> <p>No change to existing flood risk is anticipated.</p> |
| <p>WF23</p> <p>Approximate channel bed width at mainline</p> | <p>23/A9</p> <p>Grid Reference: 300461, 745549</p> | <p>Replace the existing A9 culvert with a new box culvert.</p> <p>Local regrading of channel upstream of the culvert inlet</p> | <p>Watercourse WF23 is culverted beneath the existing A9 via a 1.0m diameter concrete culvert. The proposed scheme will result in the A9 footprint at this location being widened on the upstream side (southbound carriageway) to accommodate the proposed scheme.</p> <p>Additionally, a continuous retaining wall is proposed at this location offering protection to the proposed A9 road embankment against the risk of future undermining due to lateral movement of the River Tay. The retaining wall will initially be buried and</p> |

| Waterbody | Culvert number & Location | Construction detail | Justifications for engineering solution |
|--|---------------------------|--|---|
| <p>culvert inlet: 1.4m</p> <p>Flow data: 50% AEP: 0.99m³/s 1% AEP: 1.27m³/s 0.5% AEP + CC:1.81m³/s</p> <p>Note - Flows are quoted for baseline conditions (i.e. excluding the proposed upstream diversion of WF21 & WF22 into this watercourse)</p> | | <p>and downstream of culvert outlet.</p> <p>Existing diameter = 1.0m Existing length = 35.6m</p> <p>Proposed height = 2.0m Proposed width = 2.0m Proposed length = 46.3m Proposed embedment = 0.3m</p> | <p>follows the alignment of the proposed A9 road for a linear length of 335m, intersecting watercourse WF23.</p> <p>To accommodate the proposed scheme, a number of alternative watercourse crossing options have been considered, as follows:</p> <ul style="list-style-type: none"> Retain the existing culvert unchanged: The existing culvert is not long enough to accommodate the proposed scheme. Extension of the existing culvert: The existing culvert can be extended to accommodate the footprint of the proposed scheme. However, this will not resolve the conflicts between culvert infrastructure and the proposed retaining wall along the Tay. Additionally, extending the existing culvert would not allow for mammal passage which is a requirement, preferably integral with the water culvert. Replace the existing culvert: This is the preferred option. A new box culvert will be constructed on the existing alignment, long enough to accommodate the proposed scheme and sized to provide the required mammal passage. <p>Proposed Scheme</p> <p>The preferred solution for this crossing taking account of engineering and environmental design criteria is to replace the existing culvert with a new box culvert.</p> <p>The new box culvert will follow a similar alignment to the existing culvert albeit with new inlet / outlet locations and with a revised gradient to accommodate the proposed scheme footprint. The outlet of the new culvert will tie in with the proposed retaining wall.</p> <p>The proposed diversion culvert conveying flow from Watercourse WF21 and WF 22 will drain directly into the new box culvert, immediately downstream of the proposed culvert inlet location through the side wall of the culvert or via a chamber set behind the headwall structure.</p> <p>Local regrading of the watercourse channel is required both upstream and downstream of the new culvert to tie-in with the existing channel. with the channel bed. Similarly, regrading of the downstream channel is required to accommodate the proposed outlet invert level, it is proposed to regrade the downstream watercourse from the culvert outlet to tie-in with the existing upstream channel bed levels.</p> <p>Environmental</p> <p>Ecological assessment has identified this watercourse as being an active mammal corridor and consequently there is a requirement to provide mammal passage. To facilitate this, a box culvert will be provided with mammal ledges set at the appropriate level.</p> <p>The invert of the new culvert will be buried to maintain continuity of the culvert invert gradient and natural bed material.</p> <p>Flood Risk</p> <p>The existing culvert is surcharged under the design flood event i.e. 0.5%AEP (200-year) plus an allowance for climate change. The predicted water level at the culvert inlet surcharges the culvert soffit by 0.73m, with peak water level predicted to spill out of bank within the upstream channel. Freeboard to the existing A9 road level is 1.96m, consequently the existing A9 is not considered to be at flood risk during the design flood event.</p> <p>The new culvert arrangement will also freely pass the design flood event with 0.85m culvert freeboard during the 0.5% AEP (200-year) design fluvial event. The head water depth at the culvert entrance is predicted to decrease by 0.25m as a result of</p> |

| Waterbody | Culvert number & Location | Construction detail | Justifications for engineering solution |
|--|---|---|--|
| | | | <p>the increase in culvert size.</p> <p>The available flood freeboard between headwater level and the proposed A9 road level is 1.99m, hence the proposed scheme is not considered to be at flood risk during design flood event. The head water level is out of bank in the upstream channel however, as there are no sensitive receptors in the upstream reach no further mitigation measures are considered necessary.</p> <p>Downstream flood risk is impacted by the proposed scheme, as additional flow is introduced from the diversion of WF21 and WF22 and the larger culvert barrel no longer throttles the design flow upstream. However, the 0.957m³/s increase in peak flow at WF23 is considered negligible compared to peak flow in the River Tay located immediately downstream. As such, no mitigation measures are considered necessary.</p> |
| <p>WF24</p> <p>Approximate channel bed width at mainline culvert inlet: 1.2m</p> <p>Flow data: 50% AEP: 0.28m³/s 1% AEP: 0.36m³/s 0.5% AEP + CC: 0.50m³/s</p> | <p>24/A9</p> <p>Grid Reference: 300440, 745780</p> | <p>Replacement of existing A9 culvert with a new box culvert.</p> <p>Local regrading of channel upstream of the culvert inlet and downstream of culvert outlet.</p> <p>Existing diameter = 1.0m Existing length = 40.4m Existing embedment = 0.30m</p> <p>Proposed height = 1.50m Proposed width = 1.80m Proposed length = 43.4m Proposed embedment = 0.3m</p> | <p>Watercourse WF24 is culverted beneath the existing A9 via a 1.0m diameter concrete culvert. The proposed scheme will result in the A9 footprint at this location being widened on both sides to accommodate the scheme. The widening of the A9 footprint impacts the location of the existing culvert inlet, on the upstream side (southbound). Additionally, a continuous retaining wall is proposed at this location offering protection to the proposed A9 road embankment against the risk of future undermining due to lateral movement of the River Tay. The retaining wall will initially be buried and follows the alignment of the proposed A9 road for a linear length of 335m, intersecting watercourse WF24.</p> <p>To accommodate the proposed scheme, a number of alternative watercourse crossing options have been considered, as follows:</p> <ul style="list-style-type: none"> Retain the existing culvert unchanged: The existing culvert is not long enough to accommodate the proposed scheme. Extension of the existing culvert: The existing culvert can be extended to accommodate the footprint of the proposed scheme. However, this will not resolve the conflicts between culvert infrastructure and the proposed retaining wall along the Tay. Additionally, extending the existing culvert will not allow for mammal passage which is a requirement, preferably integral with the water culvert. Replace the existing culvert: This is the preferred option. A new box culvert will be constructed on the existing alignment, long enough to accommodate the proposed scheme and sized to provide the required mammal passage. <p>Proposed Scheme</p> <p>The preferred solution for this crossing taking account of engineering and environmental design criteria is to replace the existing culvert with a new box culvert. scheme.</p> <p>The new box culvert will follow a similar alignment to the existing culvert albeit with new inlet / outlet locations and with a revised gradient to accommodate the proposed scheme footprint. The outlet of the new culvert will tie in with the proposed retaining wall.</p> <p>Local regrading of the watercourse channel is required both upstream and downstream of the new culvert to tie-in with the existing channel. with the channel bed. Similarly, regrading of the downstream channel is required to accommodate the proposed outlet invert level, it is proposed to regrade the downstream watercourse from the culvert outlet to tie-in with the existing upstream channel bed levels.</p> |

| Waterbody | Culvert number & Location | Construction detail | Justifications for engineering solution |
|--|---|--|--|
| | | | <p>Environmental</p> <p>Ecological assessment has identified this watercourse as being an active mammal corridor and consequently there is a requirement to provide mammal passage. To facilitate this, a box culvert will be provided with mammal ledges set at the appropriate level.</p> <p>The invert of the new culvert will be buried to maintain continuity of the culvert invert gradient and natural bed material.</p> <p>Flood Risk</p> <p>The existing culvert freely passes the design flood event i.e. 0.5%AEP (200-year) plus an allowance for climate change with 0.41m flood freeboard. Consequently, the existing A9 is not considered to be at flood risk during the design flood event.</p> <p>The new culvert arrangement will also freely pass the design flood event with 0.80m culvert freeboard during the 0.5% AEP (200-year) design fluvial event. The head water depth at the culvert entrance is predicted to decrease by 0.06m as a result of the increase in culvert size.</p> <p>The available flood freeboard between headwater level and the proposed A9 road level is 3.85m, hence the proposed scheme is not considered to be at flood risk during design flood event. The head water level is out of bank in the upstream channel however, as there are no sensitive receptors in the upstream reach no further mitigation measures are considered necessary.</p> <p>Downstream flood risk is not impacted by the proposed scheme.</p> |
| <p>WF25</p> <p>Approximate channel bed width at mainline culvert inlet: 1.8m</p> <p>Flow data: 50% AEP: 0.26m³/s 1% AEP: 0.33m³/s 0.5% AEP + CC: 0.46m³/s</p> | <p>25/A9</p> <p>Grid Reference: 300415, 745914</p> | <p>Upstream extension of the existing culvert.</p> <p>New cascade feature to lower upstream watercourse to new culvert entrance invert level.</p> <p>Existing diameter = 1.05m Existing length = 31.9m</p> <p>Proposed diameter = 1.05m Proposed extension = 7.5m Proposed embedment = 0m</p> | <p>Watercourse WF25 is culverted beneath the existing A9 via a 1.05m diameter concrete culvert. The proposed scheme will result in the A9 footprint at this location being widened on the downstream side (southbound carriageway) to accommodate the scheme. The widening of the A9 footprint will impact the location of the existing culvert inlet, on its upstream side.</p> <p>To accommodate the proposed scheme, a number of alternative watercourse crossing options have been considered, as follows:</p> <ul style="list-style-type: none"> Retain the existing culvert unchanged: The existing culvert is not long enough to accommodate the proposed scheme. Extension of the existing culvert: As the existing culvert plan and vertical alignment does not conflict with the proposed scheme road and drainage levels, this is considered to be the preferred option. The existing culvert will be extended upstream to accommodate the proposed scheme. Replace the existing culvert: The existing culvert could be replaced however this has been considered unnecessary in view of the suitability of the extension option. <p>Proposed Scheme</p> <p>The preferred solution for this crossing taking account of engineering and environmental design criteria is to extend the existing culvert in an upstream direction by 7.5m to accommodate the proposed scheme.</p> <p>The new culvert section will have an identical internal diameter, alignment and gradient as the existing culvert.</p> <p>To accommodate the proposed culvert invert levels, a new cascade feature will be required to convey the flow of water to the culvert entrance. The proposed geometry of the cascade is shown on the drawing (Section 5) and the nature of the cascade will be further developed at both specimen and detail design stage, but will likely be either a bedrock cascade, natural</p> |

| Waterbody | Culvert number & Location | Construction detail | Justifications for engineering solution |
|---|---|--|---|
| | | | <p>cascade or concrete (stone pitched) cascade.</p> <p>Environmental</p> <p>There is no provision for mammal passage in the existing culvert. Ecological assessment has not identified this watercourse as a potential mammal corridor, hence no provision of mammal ledges etc. with the existing and extended culvert sections is proposed.</p> <p>The culvert invert is specified to be embedded through the proposed culvert extension to maintain continuity of the culvert invert gradient and natural bed material.</p> <p>Flood Risk</p> <p>The existing culvert freely passes the design flood event i.e. 0.5%AEP (200-year) plus an allowance for climate change with 0.54m flood freeboard. Consequently, the existing A9 is not considered to be at flood risk during the design flood event.</p> <p>The new culvert arrangement will also freely pass the design flood event with 0.32m culvert freeboard. The head water depth at the culvert entrance is predicted to increase by 0.16m as a result of the extension of the culvert.</p> <p>The available freeboard between headwater level and the proposed A9 road level is predicted to be 1.95m, hence the proposed scheme is not considered to be at flood risk during design flood event. As the head water level is contained within the upstream channel, no upstream mitigation measures are considered necessary.</p> <p>Downstream flood risk is not impacted by the proposed scheme.</p> |
| <p>WF28</p> <p>Approximate channel bed width at mainline culvert inlet: 1.6m</p> <p>Flow data: 50% AEP: 0.13m³/s 1% AEP: 0.17m³/s 0.5% AEP + CC: 0.23m³/s</p> | <p>28/A9</p> <p>Grid Reference: 300351, 746212</p> | <p>No changes are proposed to the existing A9 mainline culvert.</p> <p>Existing diameter = 1.0m Existing length = 60m</p> | <p>Watercourse 28 is culverted beneath the existing A9. At this location, the proposed scheme will not widen the existing road footprint beyond the existing culvert inlet and outlet, nor will the proposed scheme infrastructure conflict with the existing culvert.</p> <p>Therefore, it is proposed to retain the existing culvert unchanged, hence the proposed scheme will not impact on the existing hydraulic regime and flood risk.</p> <p>Proposed Scheme</p> <p>The existing culvert is adequate to accommodate the proposed scheme at this location.</p> <p>Environmental</p> <p>No change to the existing culvert and local watercourse is proposed.</p> <p>Flood risk</p> <p>The existing culvert freely passes the design flood event i.e. 0.5%AEP (200-year) plus an allowance for climate change with 0.56m flood freeboard.</p> <p>The available flood freeboard between headwater level and the proposed A9 road level is 2.77m. Consequently, the existing A9 is not considered to be at flood risk during the design flood event.</p> <p>No change to existing flood risk is anticipated</p> |
| <p>WF29</p> <p>Approximate channel bed width at mainline</p> | <p>29/A9</p> <p>Grid Reference: 300335, 746287</p> | <p>No changes are proposed to the existing A9 mainline culvert.</p> | <p>Watercourse 29 is culverted beneath the existing A9. At this location, the proposed scheme will not widen the existing road footprint beyond the existing culvert inlet and outlet, nor will the proposed scheme infrastructure conflict with the existing culvert.</p> <p>Therefore, it is proposed to retain the existing culvert unchanged, hence the proposed scheme will not impact on the existing hydraulic regime and flood risk.</p> |

| Waterbody | Culvert number & Location | Construction detail | Justifications for engineering solution |
|---|---|--|---|
| <p>culvert inlet: 1.7m</p> <p>Flow data: 50% AEP: 0.30m³/s 1% AEP: 0.39m³/s 0.5% AEP + CC: 0.55m³/s</p> | | <p>Existing diameter = 1.0m Existing length = 50.5m</p> | <p>Proposed Scheme The existing culvert is adequate to accommodate the proposed scheme at this location.</p> <p>Environmental No change to the existing culvert and local watercourse is proposed.</p> <p>Flood risk The existing culvert freely passes the design flood event i.e. 0.5%AEP (200-year) plus an allowance for climate change with 0.41m flood freeboard. The available flood freeboard between headwater level and the proposed A9 road level is 5.88m. Consequently, the existing A9 is not considered to be at flood risk during the design flood event. No change to existing flood risk is anticipated</p> |
| <p>WF30</p> <p>Approximate channel bed width at mainline culvert inlet: 2.0m</p> <p>Flow data: 50% AEP: 0.26m³/s 1% AEP: 0.33m³/s 0.5% AEP + CC: 0.47m³/s</p> | <p>30/A9</p> <p>Grid Reference: 300316, 746371</p> | <p>Replacement of existing A9 culvert with new box culvert.</p> <p>Existing diameter = 1.0m Existing length = 43.7m</p> <p>Proposed height = 1.5m Proposed width = 1.5m Proposed length = 53.4m Proposed embedment = 0.15m</p> | <p>Watercourse WF30 is culverted beneath the existing A9 via a 1.0m diameter concrete culvert. The proposed scheme will result in the A9 footprint at this location being widened on the upstream side (southbound carriageway) to accommodate the scheme including a new adjacent side road. The widening of the road footprint extends out to meet the adjacent hillside, impacting the location of the existing culvert inlet.</p> <p>To accommodate the proposed scheme, a number of alternative watercourse crossing options have been considered, as follows:</p> <ul style="list-style-type: none"> Retain the existing culvert unchanged: The existing culvert is not long enough to accommodate the proposed scheme. Extension of the existing culvert: The existing culvert could be extended to accommodate the footprint of the proposed scheme, however this will require a large headwall structure at the culvert inlet to accommodate the existing culvert infrastructure which is set approx. 7m beneath the proposed road level. This will have a significant impact in terms of increasing the footprint of the road, visual impact and also contribute to increased capital cost. Replace the existing culvert: This is the preferred option: that the culvert will be replaced with a new box culvert on the existing plan alignment, at a new gradient, to accommodate the proposed scheme. <p>Proposed Scheme The preferred solution for this crossing, taking account of engineering and environmental design criteria, is to replace the existing culvert at a revised steepened gradient to accommodate the proposed scheme.</p> <p>The proposed scheme will require an earthwork "fill" onto the adjacent upstream floodplain, extending out to meet the adjacent hillside, in order to accommodate the new southbound carriageway. The new box culvert replaces the existing culvert on the same plan alignment with the culvert exit location retained. A new culvert inlet is proposed at the edge of the upstream road verge, raised to tie in with the existing upstream channel on the adjacent hillside.</p> <p>To accommodate the proposed new box culvert invert levels, it is proposed to regrade the upstream watercourse from the culvert inlet to tie-in with the existing upstream channel bed levels.</p> |

| Waterbody | Culvert number & Location | Construction detail | Justifications for engineering solution |
|---|---|---|---|
| | | | <p>Environmental</p> <p>There is no provision for mammal passage in the existing culverts, however ecological assessment has identified this watercourse as an existing and/or potential mammal corridor providing connectivity between habitats either side of the A9. To facilitate this, a box culvert will be provided with mammal ledges set at the appropriate level.</p> <p>The invert of the new culvert will be buried to maintain continuity of the culvert invert gradient and natural bed material.</p> <p>Flood Risk</p> <p>The existing culvert freely passes the design flood event i.e. 0.5%AEP (200-year) plus an allowance for climate change with 0.45m flood freeboard. Consequently, the existing A9 is not considered to be at flood risk during the design flood event.</p> <p>The new culvert arrangement will also freely pass the design flood event with 0.73m culvert freeboard. The head water depth at the culvert entrance is predicted to increase by 0.10m as a result of the extension of the culvert and incorporation of embedment in the extended culvert.</p> <p>The available flood freeboard between headwater level and the proposed A9 road level is 1.87m, hence the proposed scheme is not considered to be at flood risk during design flood event. As the head water level is contained within the upstream channel, no further mitigation measures are considered necessary.</p> <p>Downstream flood risk is not impacted by the proposed scheme.</p> |
| <p>WF31</p> <p>Approximate channel bed width at mainline culvert inlet: 1.5m</p> <p>Flow data: 50% AEP: 0.57m³/s 1% AEP: 0.72m³/s 0.5% AEP + CC: 1.03m³/s</p> | <p>31/A9</p> <p>Grid Reference: 300247, 746638</p> | <p>Upstream extension of the existing culvert.</p> <p>New cascade feature to lower upstream watercourse to new culvert invert level.</p> <p>Existing diameter = 1.0m Existing Length = 56.1m</p> <p>Proposed diameter = 1.0m Proposed extension = 7.4m Proposed embedment = 0m</p> | <p>Watercourse WF31 is culverted beneath the existing A9 via a 1.0m diameter concrete culvert. The proposed scheme will result in the A9 footprint at this location being widened on the both sides (northbound and southbound carriageway) to accommodate the proposed scheme including a new adjacent side road. The widening of the A9 footprint impacts the location of the existing culvert inlet.</p> <p>To accommodate the proposed scheme, a number of alternative watercourse crossing options have been considered, as follows:</p> <ul style="list-style-type: none"> Retain the existing culvert unchanged: The existing culvert is not long enough to accommodate the proposed scheme. Extension of the existing culvert: As the existing culvert alignment and level does not conflict with the proposed scheme infrastructure, this is considered to be the preferred option. The existing culvert will be extended upstream to accommodate the proposed scheme. Replace the existing culvert: The existing culvert could be replaced; however, this has been considered unnecessary in view of the suitability of the extension option. <p>Proposed Scheme</p> <p>The preferred solution for this crossing taking account of engineering and environmental design criteria is to extend the existing culvert by 7.4m in an upstream direction to accommodate the proposed scheme.</p> <p>The new culvert section will have a similar internal diameter and identical alignment and gradient as the existing culvert. The soffit level at the connection to the existing culvert is to be matched by the extension. The culvert invert gradient will be maintained in the extension by placement of natural bed material in the culvert invert to proposed depth of embedment.</p> <p>To accommodate the proposed culvert invert levels, a new cascade feature will be required to convey the flow of water to the culvert entrance. The proposed geometry of the cascade is shown on the drawing (Section 5) and the nature of the cascade</p> |

| Waterbody | Culvert number & Location | Construction detail | Justifications for engineering solution |
|--|---|--|---|
| | | | <p>will be further developed at specimen and detail design stage, but will likely be either a bedrock cascade, natural cascade or concrete (stone pitched) cascade.</p> <p>Environmental</p> <p>There is no provision for mammal passage in the existing culvert. Ecological assessment has identified this watercourse as a potential mammal corridor, however the existing culvert cross-section cannot accommodate mammal ledges compliant with DMRB HA81/99 geometry, hence no provision of mammal ledges etc. within the existing and extended culvert sections is proposed. An alternative mammal crossing has been established at WF30 with connection between corridors provided via mammal fencing.</p> <p>The culvert invert is specified to be embedded through the proposed culvert extension to maintain continuity of the culvert invert gradient and natural bed material.</p> <p>Flood Risk</p> <p>The existing culvert freely passes the design flood event i.e. 0.5%AEP (200-year) plus an allowance for climate change, with 0.16m flood freeboard. Consequently, the existing A9 is not considered to be at flood risk during the design flood event.</p> <p>The new culvert arrangement will also freely pass the design flood event with 0.26m culvert freeboard. The head water depth at the culvert entrance is predicted to increase by 0.02m as a result of the extension. Currently the culvert is being extended to accommodate the proposed road scheme. Increasing the size of the culvert to achieve freeboard requirements would involve replacing the full culvert length which is not considered necessary.</p> <p>The available freeboard between headwater level and the proposed A9 road level is predicted to be 3.15m, hence the proposed scheme is not considered to be at flood risk during design flood event. As the head water level is contained within the upstream channel, no upstream mitigation measures are considered necessary.</p> <p>Downstream flood risk is not impacted by the proposed scheme.</p> |
| <p>WF32</p> <p>Approximate channel bed width at mainline culvert inlet: 2.4m</p> <p>Flow data: 50% AEP: 0.87m³/s 1% AEP: 1.12m³/s 0.5% AEP + CC: 1.60m³/s</p> | <p>32/A9</p> <p>Grid Reference: 300239, 747104</p> | <p>Replacement of existing A9 culvert with new culvert, including gradient change via manhole on road verge.</p> <p>New cascade feature to convey flow to downstream watercourse from new culvert invert level.</p> <p>Existing diameter = 1.05m Existing length = 56.1m</p> <p>Proposed diameter = 1.6m Proposed length = 106.5m Proposed embedment = 0.2m</p> | <p>Watercourse WF32 is culverted beneath the existing A9 via a 1.05m diameter concrete culvert. The proposed scheme will result in the A9 footprint at this location being widened on the upstream side (southbound carriageway) to accommodate the proposed scheme including a new adjacent slip road. The widening of the A9 footprint impacts the location of the existing culvert inlet.</p> <p>To accommodate the proposed scheme, a number of alternative watercourse crossing options have been considered, as follows:</p> <ul style="list-style-type: none"> • Retain the existing culvert unchanged: The existing culvert is not long enough to accommodate the proposed scheme. • Extension of the existing culvert: The existing culvert can be extended to accommodate the footprint of the proposed scheme, however this will not resolve the conflicts between culvert infrastructure and proposed scheme road and drainage levels as well as the proposed retaining wall at the side road junction. Resolving these conflicts will require elevating the proposed scheme road surface and drainage levels and removal of the retaining wall to accommodate the existing culvert infrastructure. This would have a significant impact in terms of increasing the footprint of the road, drainage design, visual impact and also contribute to increased capital cost. • Replace the existing culvert: This is the preferred option: that the culvert will be replaced by a new alignment to accommodate the |

| Waterbody | Culvert number & Location | Construction detail | Justifications for engineering solution |
|-----------|---------------------------|---------------------|--|
| | | | <p>proposed scheme.</p> <p>Proposed Scheme</p> <p>The preferred solution for this crossing, taking account of engineering and environmental design criteria, is to replace the existing culvert with a new culvert to accommodate the proposed scheme. The proposed new culvert will have a larger internal diameter, following a new plan alignment and gradient from the existing culvert.</p> <p>The proposed scheme will require an earthwork 'cut' into the adjacent hillside with a retaining wall, to win space to accommodate the new southbound carriageway and side road junction. The vertical retaining wall will pass through the existing upstream channel.</p> <p>To pass through the proposed retaining wall to the culvert outlet location, the new culvert will require both a change in gradient and direction via a manhole located in the verge between the retaining wall and the side road junction. The proposed culvert inlet will be located upstream of the new retaining wall on the adjacent hillside and will pass through the retaining wall to the manhole, the culvert will then pass beneath the proposed A9 mainline to the new outlet location on the downstream (northbound carriageway) side.</p> <p>To accommodate the proposed culvert invert levels, a new cascade feature will be required to convey the flow of water from the culvert outlet to the existing downstream channel. The proposed geometry of the cascade is shown on the drawing (Section 5) and the nature of the cascade will be further developed at specimen and detail design stage, but will likely be either a bedrock cascade, natural cascade or concrete (stone pitched) cascade.</p> <p>Local regrading of the upstream watercourse is proposed to tie-in the culvert inlet with the existing upstream channel bed levels.</p> <p>Environmental</p> <p>There is no provision for mammal passage in the existing culvert. Ecological assessment has identified this watercourse as a potential mammal corridor.</p> <p>Mammal access has not been provided due to the change in gradient necessitated by the retaining wall will preventing a clear line of sight between the inlet and outlet. Without a straight culvert alignment and view of the outlet, mammals would be highly unlikely to use any access provided. Removing the change in gradient will require elevating the proposed scheme road surface, having a significant impact in terms of increasing the footprint of the road and contributing to increased capital cost, hence no provision of mammal ledges etc. within the new culvert sections is proposed.</p> <p>An alternative mammal crossing has been established via a dry mammal underpass at approx. chainage 3550m with connection between corridors provided via mammal fencing.</p> <p>The invert of the new culvert will be buried to maintain continuity of the culvert invert gradient and natural bed material.</p> <p>Flood Risk</p> <p>The existing culvert is surcharged by 0.34m under the design flood event i.e. 0.5%AEP (200-year) plus an allowance for climate change. To pose risk to the A9, headwater levels require to overtop the inlet headwall. Under baseline conditions with the existing culvert there is 1.37m freeboard from the headwater level to the spill level and peak water level is contained within the banks of the upstream channel. Consequently, the existing A9 is not considered to be at flood risk during the design flood event</p> <p>The new culvert arrangement will freely pass the design flood event, with 0.49m culvert freeboard during the 0.5% AEP (200-year) design fluvial event. The head water depth at the culvert entrance is predicted to decrease by 0.1m as a result of the proposed culvert arrangement.</p> |

| Waterbody | Culvert number & Location | Construction detail | Justifications for engineering solution |
|--|---|---|---|
| | | | <p>The proposed inlet will be set above the proposed A9 road level, beyond the retaining wall. The design flood event is predicted to remain in bank upstream of the culvert inlet, hence the proposed scheme is not considered to be at flood risk. No further mitigation measures are considered necessary.</p> <p>Downstream flood risk is impacted by the proposed scheme, as the larger culvert barrel no longer throttles the design flow upstream. However, the 0.531m³/s increase in peak flow at WF32 is considered negligible compared to peak flow in the River Tay located immediately downstream. As such, no mitigation measures are considered necessary.</p> |
| <p>WF33</p> <p>Approximate channel bed width at mainline culvert inlet: 1.0m</p> <p>Flow data: 50% AEP: 0.22m³/s 1% AEP: 0.28m³/s 0.5% AEP + CC: 0.39m³/s</p> | <p>33/A9</p> <p>Grid Reference: 300249, 747219</p> | <p>Replacement of existing A9 culvert with new culvert, including gradient change via manhole on road verge.</p> <p>Local regrading of channel upstream of the culvert inlet and new cascade feature to convey flow to downstream watercourse from new culvert invert level.</p> <p>Existing diameter = 1.1m Existing length = 56.1m</p> <p>Proposed diameter = 1.05m Proposed length = 62.5m Proposed embedment = 0.15m</p> | <p>Watercourse WF33 is culverted beneath the existing A9 via a 1.1m diameter concrete culvert. The proposed scheme will result in the A9 footprint at this location being widened on the upstream side (southbound carriageway) to accommodate the proposed scheme including a new adjacent side road. The widening of the A9 footprint impacts the location of the existing culvert inlet.</p> <p>To accommodate the proposed scheme, a number of alternative watercourse crossing options have been considered, as follows:</p> <ul style="list-style-type: none"> Retain the existing culvert unchanged: The existing culvert is not long enough to accommodate the proposed scheme. Extension of the existing culvert: The existing culvert could be extended to accommodate the footprint of the proposed scheme, however this will not resolve the conflicts between culvert infrastructure and proposed scheme road and drainage levels. Resolving these conflicts will require elevating the proposed scheme road surface and drainage levels and removal of the retaining wall to accommodate the existing culvert infrastructure. This would have a significant impact in terms of increasing the footprint of the road, drainage design, visual impact and also contribute to increased capital cost. Replace the existing culvert: This is the preferred option: that the culvert will be replaced by a new alignment to accommodate the proposed scheme. <p>Proposed Scheme</p> <p>The preferred solution for this crossing, taking account of engineering and environmental design criteria, is to replace the existing culvert with a new culvert to accommodate the proposed scheme. The proposed new culvert will have a similar internal diameter, following a new plan alignment and gradient from the existing culvert.</p> <p>The proposed scheme will require an earthwork 'cut' into the adjacent hillside with a retaining wall, to win space to accommodate the new southbound carriageway and side road junction. The vertical retaining wall will pass through the existing upstream channel.</p> <p>To convey flow through the retaining wall, to the outlet location, the new culvert will have a change in gradient and direction via a manhole, located in the verge between the new retaining wall and the side road junction. The proposed culvert inlet will be located upstream of the retaining wall on the adjacent hillside and will pass through the retaining wall to the manhole, the culvert will then pass beneath the proposed A9 mainline to the new outlet location on the downstream (northbound) side.</p> <p>To accommodate the proposed culvert invert levels, a new cascade feature will be required to convey the flow of water from the culvert outlet to the existing downstream channel. The proposed geometry of the cascade is shown on the drawing (Section 5) and the nature of the cascade will be further developed at both specimen and detail design stage, but will likely be either a bedrock cascade, natural cascade or concrete (stone pitched) cascade.</p> <p>Local regrading of the upstream watercourse is proposed to tie-in the culvert inlet with the existing upstream channel bed</p> |

| Waterbody | Culvert number & Location | Construction detail | Justifications for engineering solution |
|--|---|---|--|
| | | | <p>levels.</p> <p>Environmental</p> <p>There is no provision for mammal passage in the existing culvert. Ecological assessment has identified this watercourse as a potential mammal corridor.</p> <p>Mammal access has not been provided due to the change in gradient necessitated by the retaining wall will preventing a clear line of sight between the inlet and outlet. Without a straight culvert alignment and view of the outlet, mammals would be highly unlikely to use any access provided. Removing the change in gradient will require elevating the proposed scheme road surface, having a significant impact in terms of increasing the footprint of the road and contributing to increased capital cost, hence no provision of mammal ledges etc. within the new culvert sections is proposed.</p> <p>An alternative mammal crossing has been established via a dry mammal underpass at approx. chainage 3550m, with connection between corridors provided via mammal fencing.</p> <p>The invert of the new culvert will be buried to maintain continuity of the culvert invert gradient and natural bed material.</p> <p>Flood Risk</p> <p>The existing culvert freely passes the design flood event i.e. 0.5%AEP (200-year) plus an allowance for climate change, with 0.19m flood freeboard. To pose risk to the A9, headwater levels require to overtop the inlet headwall. Under baseline conditions with the existing culvert there is 1.08m freeboard from the headwater level to the spill level. Consequently, the existing A9 is not considered to be at flood risk during the design flood event</p> <p>The new culvert arrangement will also freely pass the design flood event, with 0.40m culvert freeboard during the 0.5% AEP (200-year) design fluvial event. The head water depth at the culvert entrance is predicted to decrease by 0.16m as a result of the proposed culvert and inlet arrangement.</p> <p>The proposed inlet will be set above the proposed A9 road level, beyond the retaining wall and the design flood event is predicted to remain in bank upstream of the culvert inlet, hence the proposed scheme is not considered to be at flood risk. No further mitigation measures are considered necessary.</p> <p>Downstream flood risk is not impacted by the proposed scheme.</p> |
| <p>WF34</p> <p>Approximate channel bed width at mainline culvert inlet: 0.9m</p> <p>Flow data: 50% AEP: 0.41m³/s 1% AEP: 0.52m³/s 0.5% AEP + CC: 0.74m³/s</p> | <p>34/A9</p> <p>Grid Reference: 300251, 747300</p> | <p>Replacement of existing A9 culvert with new culvert, including gradient change via manhole on road verge.</p> <p>Local regrading of channel upstream of the culvert inlet and downstream of culvert outlet.</p> <p>Existing diameter = 1.2m Existing length = 41.3m</p> | <p>Watercourse WF34 is culverted beneath the existing A9 via a 1.2m diameter concrete culvert. The proposed scheme will result in the A9 footprint at this location being widened on the upstream side (southbound carriageway) to accommodate the proposed scheme, including a new adjacent side road. The widening of the A9 footprint impacts the location of the existing culvert inlet.</p> <p>To accommodate the proposed scheme, a number of alternative watercourse crossing options have been considered, as follows:</p> <ul style="list-style-type: none"> Retain the existing culvert unchanged: The existing culvert is not long enough to accommodate the proposed scheme. Extension of the existing culvert: The existing culvert could be extended to accommodate the footprint of the proposed scheme, however this will not resolve the conflicts between culvert infrastructure and proposed scheme road and drainage levels. Resolving these conflicts will require elevating the proposed scheme road surface and drainage levels and removal of the retaining wall to accommodate the existing culvert infrastructure. This would have a significant impact in terms of increasing the footprint of the road, drainage design, visual impact and also contribute to increased capital cost. |

| Waterbody | Culvert number & Location | Construction detail | Justifications for engineering solution |
|-----------|---------------------------|---|---|
| | | <p>Proposed diameter = 1.2m Proposed length = 59.5m Proposed embedment = 0.2m</p> | <ul style="list-style-type: none"> Replace the existing culvert: This is the preferred option: that the culvert will be replaced to a new alignment to accommodate the proposed scheme. <p>Proposed Scheme</p> <p>The preferred solution for this crossing, taking account of engineering and environmental design criteria, is to replace the existing culvert with a new culvert to accommodate the proposed scheme. The proposed new culvert will have a similar internal diameter, following a new plan alignment and gradient from the existing culvert.</p> <p>The proposed scheme will require an earthwork 'cut' into the adjacent hillside with a retaining wall, to win space to accommodate the new southbound carriageway and side road junction. The vertical retaining wall will pass through the existing upstream channel.</p> <p>To convey flow through the retaining wall, to the outlet location, the new culvert will have a change in gradient and direction via a manhole, located in the verge between the new retaining wall and the southbound carriageway. The proposed culvert inlet will be located upstream of the retaining wall on the adjacent hillside and will pass through the retaining wall to the manhole, the culvert will then pass beneath the proposed A9 mainline to the new outlet location on the downstream (northbound) side.</p> <p>To accommodate the proposed culvert invert levels, a new cascade feature will be required to convey the flow of water from the culvert outlet to the existing downstream channel. The proposed geometry of the cascade is shown on the drawing (Section 5) and the nature of the cascade will be further developed at both specimen and detail design stage, but will likely be either a bedrock cascade, natural cascade or concrete (stone pitched) cascade.</p> <p>Local regrading of the watercourse upstream is proposed to tie-in the new culvert inlet with the existing channel bed levels.</p> <p>Environmental</p> <p>There is no provision for mammal passage in the existing culvert. Ecological assessment has identified this watercourse as a potential mammal corridor.</p> <p>Mammal access has not been provided due to the change in gradient necessitated by the retaining wall will preventing a clear line of sight between the inlet and outlet. Without a straight culvert alignment and view of the outlet, mammals would be highly unlikely to use any access provided. Removing the change in gradient will require elevating the proposed scheme road surface, having a significant impact in terms of increasing the footprint of the road and contributing to increased capital cost, hence no provision of mammal ledges etc. within the new culvert sections is proposed.</p> <p>An alternative mammal crossing has been established via a dry mammal underpass at approx. chainage 3550m with connection between corridors provided via mammal fencing.</p> <p>The invert of the new culvert will be buried to maintain continuity of the culvert invert gradient and natural bed material.</p> <p>Flood Risk</p> <p>The existing culvert freely passes the design flood event i.e. 0.5%AEP (200-year) plus an allowance for climate change, with 0.06m flood freeboard. Consequently, the existing A9 is not considered to be at flood risk during the design flood event.</p> <p>The new culvert arrangement will freely pass the design flood event, with 0.44m culvert freeboard during the 0.5% AEP (200-year) design fluvial event. The head water depth at the culvert entrance is predicted to decrease by 0.03m as a result of the proposed culvert and inlet arrangement.</p> <p>The proposed inlet will be set above the proposed A9 road level, beyond the retaining wall and the design flood event is predicted to remain in bank upstream of the culvert inlet, hence the proposed scheme is not considered to be at flood risk.</p> |

| Waterbody | Culvert number & Location | Construction detail | Justifications for engineering solution |
|--|---|--|---|
| | | | <p>No further mitigation measures are considered necessary.</p> <p>Downstream flood risk is not impacted by the proposed scheme.</p> |
| <p>WF35</p> <p>Approximate channel bed width at mainline culvert inlet: 1.6m</p> <p>Flow data: 50% AEP: 0.42m³/s 1% AEP: 0.54m³/s 0.5% AEP + CC: 0.77m³/s</p> | <p>35/A9</p> <p>Grid Reference: 300229, 747581</p> | <p>Upstream extension of the existing culvert.</p> <p>New cascade feature to lower upstream watercourse to new culvert invert level.</p> <p>Existing diameter = 1.2m Existing length = 25.9m</p> <p>Proposed diameter = 1.2m Proposed extension = 9.6m Proposed embedment = 0 m</p> | <p>Watercourse WF35 is culverted beneath the existing A9 via a 1.2m diameter concrete culvert. The proposed scheme will result in the A9 footprint at this location being widened on the upstream side (southbound carriageway) to accommodate the dualling of the A9 mainline. The widening of the A9 footprint impacts the location of the existing culvert inlet.</p> <p>To accommodate the proposed scheme, a number of alternative watercourse crossing options have been considered, as follows:</p> <ul style="list-style-type: none"> Retain the existing culvert unchanged: The existing culvert is not long enough to accommodate the proposed scheme. Extension of the existing culvert: As the existing culvert alignment and levels do not conflict with the proposed scheme infrastructure, this is considered to be the preferred option. The existing culvert will be extended upstream to accommodate the proposed scheme. Replace the existing culvert: The existing culvert could be replaced however this has been considered unnecessary in view of the suitability of the extension option. <p>Proposed Scheme</p> <p>The preferred solution for this crossing taking account of engineering and environmental design criteria is to extend the existing culvert by 9.6m in an upstream direction to accommodate the proposed scheme.</p> <p>The new culvert section will have a similar internal diameter, alignment and gradient as the existing culvert. The soffit level at the connection to the existing culvert is to be matched by the extension.</p> <p>To accommodate the proposed culvert invert levels, a new cascade feature will be required to convey the flow of water to the culvert entrance. The proposed geometry of the cascade is shown on the drawing (Section 5) and the nature of the cascade will be further developed at specimen and detail design stage, but will likely be either a bedrock cascade, natural cascade or concrete (stone pitched) cascade.</p> <p>Environmental</p> <p>There is no provision for mammal passage in the existing culvert. Ecological assessment has identified this watercourse as a potential mammal corridor, however the existing culvert cross-section cannot accommodate mammal ledges compliant with DMRB HA81/99 geometry, hence no provision of mammal ledges etc. within the existing and extended culvert sections is proposed. An alternative mammal crossing has been established via a dry mammal underpass at approx. chainage 3550m, with connection between corridors provided via mammal fencing.</p> <p>The culvert invert is specified to be embedded through the proposed culvert extension to maintain continuity of the culvert invert gradient and natural bed material.</p> <p>Flood Risk</p> <p>The existing culvert freely passes the design flood event i.e. 0.5%AEP (200-year) plus an allowance for climate change, with 0.56m flood freeboard. Consequently, the existing A9 is not considered to be at flood risk during the design flood event.</p> <p>The new culvert arrangement will also freely pass the design flood event with 0.60m culvert freeboard. The head water depth</p> |

| Waterbody | Culvert number & Location | Construction detail | Justifications for engineering solution |
|--|---|--|---|
| | | | <p>at the culvert entrance is predicted to increase by 0.01m as a result of the extension.</p> <p>The available freeboard between headwater level and the proposed A9 road level is predicted to be 3.33m, hence the proposed scheme is not considered to be at flood risk during design flood event. As the head water level is contained within the upstream channel, no upstream mitigation measures are considered necessary.</p> <p>Downstream flood risk is not impacted by the proposed scheme.</p> |
| <p>WF36 (Dowally Burn)</p> <p>Approximate channel bed width at mainline culvert inlet: 4.7m</p> <p>Flow data: 50% AEP: 6.33m³/s 1% AEP: 7.78m³/s 0.5% AEP + CC: 10.50m³/s</p> | <p>36/A9/ML042</p> <p>Grid Reference: 300057, 748161</p> | <p>Upstream and downstream extension of the existing twin-box culvert.</p> <p>Removal of masonry arch bridge section</p> <p>Existing height = 1.7m Existing width = 2.6m x 2no. Existing length = 47.2m</p> <p>Proposed height = 1.7m Proposed width = 2.6m x 2no. Proposed extension upstream = 35.6m Proposed extension downstream = 18.1m Proposed embedment = 0.2m</p> | <p>Watercourse WF36 is culverted beneath the existing A9 via a concrete twin-box culvert 1.7m high by 2.6m wide per span. The proposed scheme will result in the A9 footprint at this location being widened on both the upstream and downstream sides (southbound and northbound carriageways) to accommodate the proposed scheme including new adjacent side roads. The widening of the A9 footprint impacts the location of the existing culvert inlet and outlet.</p> <p>To accommodate the proposed scheme, a number of alternative watercourse crossing options have been considered, as follows:</p> <ul style="list-style-type: none"> Retain the existing culvert unchanged: The existing culvert is not long enough to accommodate the proposed scheme. Extension of the existing culvert: As the existing culvert alignment and level does not conflict with the proposed scheme infrastructure, this is considered to be the preferred option. The existing culvert will be extended both upstream and downstream to accommodate the proposed scheme. Replace the existing culvert: The existing culvert could be replaced however this has been considered unnecessary in view of the suitability of the extension option. <p>Proposed Scheme</p> <p>The preferred solution for this crossing taking account of engineering and environmental design criteria is to extend the existing twin-box culvert by 35.6m in an upstream direction and 18.1m in a downstream direction to accommodate the proposed scheme. This will involve the removal of approximately 6.9m of the masonry arch bridge section from the inlet location.</p> <p>The new culvert section will have a similar cross section, alignment and gradient as the existing culvert; and the soffit level at the connection to the existing culvert is to be matched by the extension.</p> <p>To accommodate the proposed new culvert inlet location, it is proposed to locally regrade the upstream and downstream watercourses from the new culvert inlet and outlet locations to tie-in with the existing channel bed levels.</p> <p>Environmental</p> <p>There is no provision for mammal passage in the existing culvert. Ecological assessment has identified this watercourse as a potential mammal corridor, however the existing culvert cross-section cannot accommodate mammal ledges compliant with DMRB HA81/99 geometry, hence no provision of mammal ledges etc. within the existing and extended culvert sections is proposed. An alternative mammal crossing has been established via a dry mammal underpass at approx. chainage 4300m, with connection between corridors provided via mammal fencing.</p> <p>The culvert invert is specified to be embedded through the proposed culvert extension to maintain continuity of the culvert invert gradient and natural bed material.</p> |

| Waterbody | Culvert number & Location | Construction detail | Justifications for engineering solution |
|--|---|---|---|
| | | | <p>Flood Risk</p> <p>The existing culvert freely passes the design flood event i.e. 0.5%AEP (200-year) plus an allowance for climate change, with 0.15m flood freeboard. Consequently, the existing A9 is not considered to be at flood risk during the design flood event.</p> <p>The new culvert arrangement will also freely pass the design flood event with 0.22m culvert freeboard during the 0.5% AEP (200-year) design fluvial event. The head water depth at the culvert entrance is predicted to decrease by 0.07m despite the extension as a result of the replacement of the existing masonry arch section with a twin-box culvert.</p> <p>The available freeboard between headwater level and the proposed A9 road level is predicted to be 3.53m, hence the proposed scheme is not considered to be at flood risk during design flood event. As the head water level is contained within the upstream channel, no upstream mitigation measures are considered necessary.</p> <p>Downstream flood risk is not impacted by the proposed scheme.</p> |
| <p>WF37</p> <p>Approximate channel bed width at mainline culvert inlet: 1.1m</p> <p>Flow data: 50% AEP: 0.41m³/s 1% AEP: 0.53m³/s 0.5% AEP + CC: 0.76m³/s</p> | <p>37/A9</p> <p>Grid Reference: 300026, 748299</p> | <p>Upstream and downstream extension of existing culvert.</p> <p>Local regrading of channel upstream of the culvert inlet.</p> <p>Existing diameter = 1.05m Existing length = 43.0m</p> <p>Proposed diameter = 1.05m Proposed upstream extension = 20.6m Proposed downstream extension = 10.1m Proposed embedment = 0.15m</p> | <p>Watercourse WF37 is culverted beneath the existing A9 via a 1.06m diameter concrete culvert. The proposed scheme will result in the A9 footprint at this location being widened on both the upstream and downstream sides (southbound and northbound carriageways) to accommodate the proposed scheme including new adjacent side roads. The widening of the A9 footprint impacts the location of the existing culvert inlet, on the upstream side (southbound) and outlet, on the downstream side (northbound).</p> <p>To accommodate the proposed scheme, a number of alternative watercourse crossing options have been considered, as follows:</p> <ul style="list-style-type: none"> • Retain the existing culvert unchanged: The existing culvert is not long enough to accommodate the proposed scheme. • Extension of the existing culvert: As the existing culvert alignment and level does not conflict with the proposed scheme infrastructure, this is considered to be the preferred option. The existing culvert will be extended both upstream and downstream to accommodate the proposed scheme. • Replace the existing culvert: The existing culvert could be replaced however this has been considered unnecessary in view of the suitability of the extension option. <p>Proposed Scheme</p> <p>The preferred solution for this crossing taking account of engineering and environmental design criteria is to extend the existing culvert by 20.6m in an upstream direction and 10.1m in a downstream direction to accommodate the proposed scheme.</p> <p>The new culvert section will have a similar internal diameter, alignment and gradient as the existing culvert; and the soffit level at the connection to the existing culvert is to be matched by the extension.</p> <p>To accommodate the proposed new culvert inlet location, it is proposed to regrade the upstream watercourse from the new culvert inlet to tie-in with the existing upstream channel bed levels.</p> <p>To accommodate the proposed new outlet location, it is proposed to regrade the downstream watercourse from the new culvert outlet to tie-in with the existing channel bed levels over 9.2m downstream of the outlet.</p> <p>Additionally, further regrading works are required in the downstream channel at the connection to WF38, to tie in with the</p> |

| Waterbody | Culvert number & Location | Construction detail | Justifications for engineering solution |
|--|---|---|---|
| | | | <p>proposed outfall of the adjacent swale.</p> <p>Environmental</p> <p>There is no provision for mammal passage in the existing culvert. Ecological assessment has identified this watercourse as a potential mammal corridor, however the existing culvert cross-section cannot accommodate mammal ledges compliant with DMRB HA81/99 geometry, hence no provision of mammal ledges etc. within the existing and extended culvert sections is proposed. An alternative mammal crossing has been established via a dry mammal underpass at approx. chainage 4300m, with connection between corridors provided via mammal fencing.</p> <p>The culvert invert is specified to be embedded through the proposed culvert extension to maintain continuity of the culvert invert gradient and natural bed material.</p> <p>Flood Risk</p> <p>The existing culvert freely passes the design flood event i.e. 0.5%AEP (200-year) plus an allowance for climate change, with 0.39m flood freeboard. Consequently, the existing A9 is not considered to be at flood risk during the design flood event.</p> <p>The new culvert arrangement will also freely pass the design flood event with 0.06m culvert freeboard during the 0.5% AEP (200-year) design fluvial event. The head water depth at the culvert entrance is predicted to increase by 0.215m as a result of the extension and the introduction of embedment throughout the extended section. Currently the culvert is being extended to accommodate the proposed road scheme. Increasing the size of the culvert to achieve freeboard requirements would involve replacing the full culvert length which is not considered necessary.</p> <p>The available freeboard between headwater level and the proposed A9 road level is predicted to be 3.69m, hence the proposed scheme is not considered to be at flood risk during design flood event. As the head water level is contained within the upstream channel, no upstream mitigation measures are considered necessary.</p> <p>Downstream flood risk is not impacted by the proposed scheme.</p> |
| <p>WF38</p> <p>Approximate channel bed width at mainline culvert inlet: 0.6m</p> <p>Flow data: 50% AEP: 0.81m³/s 1% AEP: 1.07m³/s 0.5% AEP + CC: 1.51m³/s</p> | <p>38/A9 (mainline culvert)</p> <p>Grid Reference: 299990, 748530</p> | <p>Replacement of existing A9 culvert with new box culvert.</p> <p>Realignment of channel upstream of the mainline culvert inlet.</p> <p>Existing diameter = 0.6m Existing length = 22.3m</p> <p>Proposed height = 1.5m Proposed width = 2.0m Proposed length = 41.5m Proposed embedment = 0.2m</p> | <p>Watercourse WF38 is culverted beneath the existing A9 via a 1.06m diameter concrete culvert. The proposed scheme will result in the A9 footprint at this location being widened on both the upstream and downstream sides (southbound and northbound carriageways) to accommodate the proposed scheme including new adjacent side roads. The widening of the A9 footprint impacts the location of the existing culvert inlet and outlet.</p> <p>To accommodate the proposed scheme, a number of alternative watercourse crossing options have been considered, as follows:</p> <ul style="list-style-type: none"> Retain the existing culvert unchanged: The existing culvert is not long enough to accommodate the proposed scheme. Extension of the existing culvert: The existing culvert could be extended to accommodate the footprint of the proposed scheme, however this will not resolve the conflicts between culvert infrastructure and proposed scheme road and drainage levels. Resolving these conflicts will require elevating the proposed scheme road surface and drainage levels to accommodate the existing culvert infrastructure. This would have a significant impact in terms of increasing the footprint of the road, drainage design, visual impact and also contribute to increased capital cost. Replace the existing culvert: This is the preferred option: that the culvert will be replaced with a new box culvert on the existing plan alignment, at a lower gradient, to accommodate the proposed scheme. |

| Waterbody | Culvert number & Location | Construction detail | Justifications for engineering solution |
|-----------|--|--|--|
| | | | <p>Proposed Scheme</p> <p>The preferred solution for this crossing taking account of engineering and environmental design criteria is to replace the existing culvert at a revised alignment to accommodate the proposed scheme.</p> <p>The new box culvert will replace the existing culvert on the existing plan alignment and maintains the existing culvert gradient at a lowered inlet and outlet level. A new culvert inlet and outlet are proposed at the edge of the upstream (southbound) and downstream (northbound) road verges. Culvert inlet and outlet invert levels have been lowered to allow for the increase in culvert size to a box culvert without impacting the proposed scheme infrastructure.</p> <p>To accommodate the proposed new box culvert invert levels and new scheme footprint, it is proposed to realign the upstream watercourse from the culvert inlet to tie-in with the outlet of the new side road crossing upstream.</p> <p>Environmental</p> <p>Ecological assessment has identified this watercourse as being an active mammal corridor and consequently there is a requirement to provide mammal passage. To facilitate this, a box culvert will be provided with mammal ledges set at the appropriate level.</p> <p>The invert of the new culvert will be buried to maintain continuity of the culvert invert gradient and natural bed material.</p> <p>Flood Risk</p> <p>The existing culvert is surcharged under the design flood event i.e. 0.5%AEP (200-year) plus an allowance for climate change. The water level at the existing culvert inlet surcharges the culvert soffit by 2.79m, with peak water level predicted to spill out of bank within the upstream channel. The existing A9 road is likely to be at flood risk during the design flood event.</p> <p>The new box culvert has been designed to pass the 4% AEP (50-year) design flood event with appropriate freeboard to allow for mammal passage. The new box culvert arrangement will freely pass the design flood event with 0.66m culvert freeboard during the 0.5% AEP (200-year) design fluvial event. The head water depth at the culvert entrance is predicted to decrease by 2.68m, as a result of upsizing the culvert to allow for mammal passage and for free flow under design flood event.</p> <p>The available freeboard between headwater level and the proposed A9 road level is 1.81m, hence the proposed scheme is not considered to be at flood risk during design flood event. As the head water level is contained within the upstream channel, no further mitigation measures are considered necessary.</p> <p>Downstream flood risk is impacted by the proposed scheme, as the increased capacity of the culvert will result in increased flows downstream of the A9. However, the flood mitigation area immediately downstream has sufficient capacity for the increased flows and therefore any out of bank flows will be stored in the compensation area. The increase in flows downstream is small in comparison to the receiving watercourse (Dowally Burn) and any exceedance will result in shallow depths of flooding within the existing floodplain, at far lower depths than occurs during even a 3.33% (30-year) event on the River Tay. The Dowally Burn discharges into the River Tay and any increase in flows is negligible compared to the flows on the River Tay, therefore the increase in flood risk is considered negligible.</p> |
| | <p>38/US</p> <p>Grid Reference: 300057, 748512</p> | <p>Replacement of existing side road culvert with new box culvert.</p> <p>Realignment of channel upstream of the side road</p> | <p>A new culvert is required upstream of the A9 crossing to accommodate a proposed side road to the east of the A9. Watercourse WF38 is culverted beneath the existing side road via a 0.6m diameter concrete culvert which is to be replaced to allow for the widened scheme footprint and sized to allow mammal access.</p> <p>The new box culvert has been designed to pass the 0.5%AEP (200-year) design flood event with 0.68m freeboard and also allows for mammal passage.</p> <p>To accommodate the proposed new box culvert invert levels and new scheme footprint, it is proposed to realign the</p> |

| Waterbody | Culvert number & Location | Construction detail | Justifications for engineering solution |
|---|--|---|---|
| | | <p>culvert inlet.</p> <p>Proposed height = 1.5m Proposed width = 2.0m Proposed length = 29.0m Proposed embedment = 0.2m</p> | <p>upstream watercourse over approximately 60m from where the watercourse conflicts with the scheme footprint tie-in with the new side road culvert inlet.</p> <p>Ecological assessment has identified this watercourse as being an active mammal corridor and consequently there is a requirement to provide mammal passage. To facilitate this, a box culvert will be provided with mammal ledges set at the appropriate level.</p> <p>The invert of the new culvert will be buried to maintain continuity of the culvert invert gradient and natural bed material.</p> |
| | <p>38/DS</p> <p>Grid Reference: 299936, 748509</p> | <p>New side road box culvert.</p> <p>Proposed height = 1.5m Proposed width = 2.0m Proposed length = 34.8m Proposed embedment = 0.2m</p> | <p>A new culvert is required downstream of the A9 crossing to accommodate a proposed new access track to the West of the A9. There is no existing watercourse crossing at this location.</p> <p>The new box culvert has been designed to pass the 0.5% AEP (200-year) design flood event with 0.66m freeboard and also allows for mammal passage.</p> <p>Ecological assessment has identified this watercourse as being an active mammal corridor and consequently there is a requirement to provide mammal passage. To facilitate this, a box culvert will be provided with mammal ledges set at the appropriate level.</p> <p>The invert of the new culvert will be buried to maintain continuity of the culvert invert gradient and natural bed material.</p> |
| <p>WF39 (Sloggan Burn)</p> <p>Approximate channel bed width at mainline culvert inlet: 1.6m</p> <p>Flow data: 50% AEP: 2.28m³/s 1% AEP: 3.05m³/s 0.5% AEP + CC: 4.27m³/s</p> | <p>39/A9/ML052</p> <p>Grid Reference: 299800, 749085</p> | <p>Upstream and downstream extension of the existing box culvert.</p> <p>Removal of section of existing culvert at inlet</p> <p>Existing height = 1.2m Existing width = 2.4m Existing length = 20.9m</p> <p>Proposed height = 1.2m Proposed width = 2.4m Proposed extension upstream = 31.2m Proposed extension downstream = 14.2m Proposed embedment = 0.25m</p> | <p>Watercourse WF39 is culverted beneath the existing A9 via a 1.2m high by 2.4m wide concrete box culvert. The proposed scheme will result in the A9 footprint at this location being widened on both the upstream and downstream sides (southbound and northbound carriageways) to accommodate the proposed scheme including new adjacent side roads. The widening of the A9 footprint impacts the location of the existing culvert inlet and outlet.</p> <p>To accommodate the proposed scheme, a number of alternative watercourse crossing options have been considered, as follows:</p> <ul style="list-style-type: none"> Retain the existing culvert unchanged: The existing culvert is not long enough to accommodate the proposed scheme. Extension of the existing culvert: As the existing culvert alignment and level does not conflict with the proposed scheme infrastructure, this is considered to be the preferred option. The existing culvert will be extended both upstream and downstream to accommodate the proposed scheme. Replace the existing culvert: The existing culvert could be replaced however this has been considered unnecessary in view of the suitability of the extension option. <p>Proposed Scheme</p> <p>The preferred solution for this crossing taking account of engineering and environmental design criteria is to extend the existing box culvert by 31m in an upstream direction and 14m in a downstream direction to accommodate the proposed scheme. This will involve the removal of approximately 11m of existing box culvert section from the culvert inlet, replaced with 31.2m of new box culvert on a new plan alignment.</p> <p>The new culvert section will have a similar cross section, and gradient as the existing culvert. The new downstream extension will follow a similar alignment as the existing culvert while the new upstream extension will follow a new alignment</p> |

| Waterbody | Culvert number & Location | Construction detail | Justifications for engineering solution |
|---|--|--|--|
| | | | <p>to tie into the upstream channel.</p> <p>To accommodate the proposed new culvert inlet location, it is proposed to locally realign the upstream watercourse from the new culvert inlet and outlet locations to tie-in with the existing channel bed levels.</p> <p>Environmental</p> <p>There is no provision for mammal passage in the existing culvert. Ecological assessment has identified this watercourse as a potential mammal corridor, however the existing culvert cross-section cannot accommodate mammal ledges compliant with DMRB HA81/99 geometry, hence no provision of mammal ledges etc. within the existing and extended culvert sections is proposed. An alternative mammal crossing has been established at both WF38 and WF40, with connection between corridors provided via mammal fencing.</p> <p>The culvert invert is specified to be embedded through the proposed culvert extension to maintain continuity of the culvert invert gradient and natural bed material.</p> <p>Flood Risk</p> <p>The existing culvert is surcharged under the design flood event i.e. 0.5%AEP (200-year) plus an allowance for climate change. The water level at the inlet surcharges the culvert soffit by 0.80m, with peak water level outwith the banks of the upstream channel. The existing A9 road level is surcharged by 0.37m and is considered to be at flood risk during the design flood event.</p> <p>The new culvert arrangement will also be surcharged under the design flood event. The water level at the inlet surcharges the culvert soffit by 0.75m, the head water depth at the culvert entrance is predicted to decrease by 0.05m despite the extension as a result of the removal of the obstruction at the inlet.</p> <p>The available freeboard between headwater level and the proposed A9 road level is predicted to be 0.82m, hence the proposed scheme is not considered to be at flood risk during design flood event. As the head water level is contained within the upstream channel, no upstream mitigation measures are considered necessary.</p> <p>Downstream flood risk is not impacted by the proposed scheme.</p> |
| <p>WF40 (Kindallachan Burn)</p> <p>Approximate channel bed width at mainline culvert inlet: 8.5m</p> <p>Flow data: 50% AEP: 16.34m³/s 1% AEP: 20.94m³/s 0.5% AEP + CC: 28.93m³/s</p> | <p>40/A9/ML061</p> <p>Grid Reference: 299415, 749842</p> | <p>Replacement of existing A9 bridge with new bridge.</p> <p>Existing Bridge dimensions: Existing length = 13.4m Existing width (span) = 9.0m</p> <p>New Bridge dimensions: Proposed length = 30.4m Proposed width (span) = 9.0m</p> | <p>Watercourse WF40 passes beneath the existing A9 via a reinforced concrete bridge spanning 9.0m over the watercourse. The proposed scheme will result in the A9 footprint at this location being widened on the upstream side (southbound carriageway) to accommodate the proposed scheme. The widening of the A9 footprint impacts the location of the existing upstream face of the bridge.</p> <p>To accommodate the proposed scheme, a number of alternative watercourse crossing options have been considered, as follows:</p> <ul style="list-style-type: none"> Retain the existing bridge unchanged: The existing bridge is not long enough to accommodate the proposed scheme. Extension of the existing bridge: The existing bridge cannot be extended to accommodate the footprint of the proposed scheme, as this will require a movement joint between existing and extended bridge sections located within the northbound carriageway. Resolving this conflict will require realigning and elevating the proposed scheme road surface level to accommodate the existing bridge infrastructure. This would have a significant impact in terms of increasing the footprint of the road, drainage design, visual impact and also contribute to increased capital cost. Replace the existing bridge: |

| Waterbody | Culvert number & Location | Construction detail | Justifications for engineering solution |
|--|--|---|---|
| | | | <p>This is the preferred option: that the bridge will be replaced to a new alignment to accommodate the proposed scheme.</p> <p>Proposed Scheme</p> <p>The preferred solution for this crossing, taking account of engineering and environmental design criteria, is to replace the existing bridge structure with a new bridge to accommodate the proposed scheme. The proposed new bridge will have a similar span over a longer length, following a new plan alignment from the existing culvert.</p> <p>The proposed scheme will maintain the existing bed gradient, with scour protection as required beneath natural river bed deposits to maintain bed level (protection is currently provided by an existing concrete invert). The requirements of the scour protection will be determined at the specimen design stage.</p> <p>To accommodate the proposed location of the upstream headwall, it is proposed to realign the upstream watercourse over approximately 5m to tie-in with the existing upstream channel alignment.</p> <p>To accommodate the proposed location of the downstream headwall, it is proposed to realign the downstream watercourse over approximately 5m to tie-in with the existing downstream channel alignment.</p> <p>Environmental</p> <p>There is no provision for mammal passage in the existing culvert, however ecological assessment has identified this watercourse as an existing and/or potential mammal corridor providing connectivity between habitats either side of the A9, hence the provision of mammal ledges has been accommodated within the abutments of the proposed bridge.</p> <p>The new bridge cross-section is proposed to include natural river bed deposits to maintain continuity of the culvert invert gradient and natural bed material.</p> <p>Flood Risk</p> <p>The existing culvert freely passes the design flood event i.e. 0.5%AEP (200-year) plus an allowance for climate change, with 1.48m flood freeboard. Consequently, the existing A9 is not considered to be at flood risk during the design flood event.</p> <p>The new culvert arrangement will freely pass the design flood event, with 1.40m culvert freeboard during the 0.5% AEP (200-year) design fluvial event. The head water depth at the culvert entrance is predicted to decrease by 0.08m as a result of improvements to the hydraulic performance of the headwall arrangement.</p> <p>The available freeboard between headwater level and the proposed A9 road level is predicted to be 2.36m, hence the proposed scheme is not considered to be at flood risk during design flood event. The head water level is out of bank in the upstream channel, however as there are no sensitive receptors in the upstream reach no further mitigation measures are considered necessary.</p> <p>Downstream flood risk is not impacted by the proposed scheme.</p> |
| <p>WF41</p> <p>Approximate channel bed width at mainline culvert inlet: 0.4m</p> <p>Flow data: 50% AEP: 1.17m³/s</p> | <p>41/A9</p> <p>Grid Reference: 299277, 750155</p> | <p>Upstream extension of the existing culvert.</p> <p>Local regrading of channel upstream of the culvert inlet.</p> <p>Existing diameter = 1.3m Existing length = 27.9m</p> | <p>Watercourse WF41 is culverted beneath the existing A9 via a 1.3m diameter concrete culvert. The proposed scheme will result in the A9 footprint at this location being widened on the upstream side (northbound carriageway) to accommodate the proposed scheme. The widening of the A9 footprint impacts the location of the existing culvert inlet.</p> <p>To accommodate the proposed scheme, a number of alternative watercourse crossing options have been considered, as follows:</p> <ul style="list-style-type: none"> Retain the existing culvert unchanged: The existing culvert is not long enough to accommodate the proposed scheme. Extension of the existing culvert: |

| Waterbody | Culvert number & Location | Construction detail | Justifications for engineering solution |
|--|--|--|---|
| <p>1% AEP: 1.50m³/s 0.5% AEP + CC: 2.09m³/s</p> <p>Note - Flows are quoted for baseline conditions (i.e. excluding the proposed upstream diversion of WF50 into this watercourse)</p> | | <p>Proposed diameter = 1.3m Proposed extension = 20.5m Proposed embedment = 0m</p> | <p>As the existing culvert alignment and level does not conflict with the proposed scheme infrastructure, this is considered to be the preferred option. The existing culvert will be extended upstream to accommodate the proposed scheme.</p> <ul style="list-style-type: none"> Replace the existing culvert: <p>The existing culvert could be replaced; however, this has been considered unnecessary in view of the suitability of the extension option.</p> <p>Proposed Scheme</p> <p>The preferred solution for this crossing taking account of engineering and environmental design criteria is to extend the existing culvert by 20.5m in an upstream direction to accommodate the proposed scheme. The new culvert section will have an identical internal diameter, alignment and gradient as the existing culvert.</p> <p>To accommodate the proposed location of the upstream headwall, it is proposed to realign the upstream watercourse over 21.5m to tie-in with the existing upstream channel alignment.</p> <p>Environmental</p> <p>There is no provision for mammal passage in the existing culvert. Ecological assessment has identified this watercourse as a potential mammal corridor, however the existing culvert cross-section cannot accommodate mammal ledges compliant with DMRB HA81/99 geometry, hence no provision of mammal ledges etc. within the existing and extended culvert sections is proposed. An alternative mammal crossing has been established at WF40 with connection between corridors provided via mammal fencing.</p> <p>The culvert invert is specified to be embedded through the proposed culvert extension to maintain continuity of the culvert invert gradient and natural bed material.</p> <p>Flood Risk</p> <p>The existing culvert is surcharged under the design flood event, i.e. 0.5%AEP (200-year) plus an allowance for climate change. The water level at the inlet surcharges the culvert soffit by 0.16m, with peak water level predicted to spill out of bank of the upstream channel and flooding the pond area on the east of the A9. Freeboard to the existing A9 road level is 2.06m, consequently the existing A9 is not considered to be at flood risk during the design flood event.</p> <p>The new culvert arrangement will also be surcharged under the design flood event. The water level at the inlet surcharges the culvert soffit by 0.08m. The head water depth at the culvert entrance is predicted to decrease by 0.08m despite the increased length of the culvert due to a reduction in the inflow from WF42 as more flow passes over the floodplain between upstream of WF42 and downstream of WF41.</p> <p>The available freeboard between headwater level and the proposed A9 road level is predicted to be 3.54m, hence the proposed scheme is not considered to be at flood risk during design flood event. The head water level is out of bank in the upstream channel, however as there are no sensitive receptors in the upstream reach no further mitigation measures are considered necessary.</p> <p>Downstream flood risk is not impacted by the proposed scheme.</p> |
| <p>WF42</p> <p>Approximate channel bed width at mainline culvert inlet: 1.0m</p> | <p>42/A9</p> <p>Grid Reference: 299249, 750336</p> | <p>Upstream and downstream extension of the existing culvert.</p> <p>Local regrading of channel</p> | <p>Watercourse WF42 is culverted beneath the existing A9 via a 0.60m diameter concrete culvert. The proposed scheme will result in the A9 footprint at this location being widened on both the upstream and downstream (northbound and southbound carriageways) sides to accommodate the proposed scheme. The widening of the A9 footprint impacts both the location of the existing culvert inlet and outlet.</p> <p>To accommodate the proposed scheme, a number of alternative watercourse crossing options have been considered, as</p> |

| Waterbody | Culvert number & Location | Construction detail | Justifications for engineering solution |
|---|---------------------------|---|--|
| <p>Flow data: 50% AEP: 0.61m³/s 1% AEP: 0.78m³/s 0.5% AEP + CC: 1.08m³/s</p> <p>Note - Flows are quoted for baseline conditions (i.e. excluding the proposed upstream diversion of WF50 into this watercourse)</p> | | <p>upstream of the culvert inlet and downstream of the culvert outlet.</p> <p>Existing diameter = 0.6m Existing length = 27.7m</p> <p>Proposed diameter = 0.6m Proposed extension upstream = 6.7m Proposed extension downstream = 15.5m Proposed embedment = 0m</p> | <p>follows:</p> <ul style="list-style-type: none"> Retain the existing culvert unchanged: The existing culvert is not long enough to accommodate the proposed scheme. Extension of the existing culvert: As the existing culvert alignment and level does not conflict with the proposed scheme infrastructure, this is considered to be the preferred option. The existing culvert will be extended upstream and downstream to accommodate the proposed scheme. Replace the existing culvert: The existing culvert could be replaced; however, this has been considered unnecessary in view of the suitability of the extension option. <p>Proposed Scheme</p> <p>The preferred solution for this crossing taking account of engineering and environmental design criteria is to extend the existing culvert by 6.7m in an upstream direction and 15.5m in a downstream direction to accommodate the proposed scheme.</p> <p>The new culvert section will have an identical internal diameter, alignment and gradient as the existing culvert.</p> <p>To accommodate the proposed location of the upstream headwall, it is proposed to realign the upstream watercourse over 7m to tie-in with the existing upstream channel alignment.</p> <p>Additionally, to accommodate the proposed location of the downstream headwall, it is proposed to realign the downstream watercourse over approximately 16m to tie-in with the existing downstream channel alignment.</p> <p>Environmental</p> <p>There is no provision for mammal passage in the existing culvert. Ecological assessment has not identified this watercourse as a potential mammal corridor, hence no provision of mammal ledges etc. within the existing and extended culvert sections is proposed.</p> <p>The culvert invert is specified to be embedded through the proposed culvert extension to maintain continuity of the culvert invert gradient and natural bed material.</p> <p>Flood Risk</p> <p>The existing culvert is surcharged under the design flood event i.e. 0.5%AEP (200-year) plus an allowance for climate change. The water level at the inlet surcharges the culvert soffit by 0.53m, with peak water level predicted to spill out of bank within the upstream channel and pass a portion of the flow over the floodplain between upstream of WF42 and downstream of WF41. Freeboard to the existing A9 road level is 3.02m, consequently the existing A9 is not considered to be at flood risk during the design flood event.</p> <p>The new culvert arrangement will also be surcharged under the design flood event. The water level at the inlet surcharges the culvert soffit by 0.53m, the head water depth at the culvert entrance is predicted to decrease by 0.005m despite the increased length of the culvert as more flow passes over the floodplain between upstream of WF42 and downstream of WF41.</p> <p>The available freeboard between headwater level and the proposed A9 road level is 3.44m, hence the proposed scheme is not considered to be at flood risk during design flood event. The head water level is out of bank in the upstream channel with flow passing over the floodplain, however as this is an improvement to existing flooding no further mitigation measures</p> |

| Waterbody | Culvert number & Location | Construction detail | Justifications for engineering solution |
|--|--|---|---|
| | | | <p>are considered necessary.</p> <p>Downstream flood risk is not impacted by the proposed scheme.</p> |
| <p>WF47</p> <p>Approximate channel bed width at mainline culvert inlet: 1.1m</p> <p>Flow data: 50% AEP: 0.27m³/s 1% AEP: 0.34m³/s 0.5% AEP + CC: 0.47m³/s</p> <p>Note - Flows are quoted for baseline conditions (i.e. excluding the proposed upstream diversion of WF49 into this watercourse)</p> | <p>47/A9</p> <p>Grid Reference: 299152, 750612</p> | <p>Replacement of existing A9 culvert with new box culvert.</p> <p>New cascade feature to lower upstream watercourse to new culvert invert level.</p> <p>Realignment of downstream channel.</p> <p>Existing diameter = 0.90m Existing length = 26.4m</p> <p>Proposed height = 1.2m Proposed width = 1.8m Proposed length = 35.8m Proposed embedment = 0.20m</p> | <p>Watercourse WF47 is culverted beneath the existing A9 via a 0.90m diameter concrete culvert. The proposed scheme will result in the A9 footprint at this location being widened on both the upstream and downstream (northbound and southbound carriageways) to accommodate the proposed scheme including a new adjacent side road.</p> <p>The proposed scheme will also result in flow from water feature WF49 being diverted to the new confluence with water feature WF47, prior to being culverted beneath the proposed scheme. To accommodate the proposed scheme, a number of alternative watercourse crossing options have been considered, as follows:</p> <ul style="list-style-type: none"> Retain the existing culvert unchanged: The existing culvert is not long enough to accommodate the proposed scheme. Extension of the existing culvert: The existing culvert could be extended to accommodate the footprint of the proposed scheme, however this will not resolve the conflicts between culvert infrastructure and proposed scheme road and drainage levels. Resolving these conflicts will require elevating the proposed scheme road surface and drainage level to accommodate the existing culvert infrastructure. This would have a significant impact in terms of increasing the footprint of the road, drainage design, visual impact and also contribute to increased capital cost. Replace the existing culvert: This is the preferred option: that the culvert will be replaced with a new box culvert on a new alignment and gradient to accommodate the proposed scheme. <p>Proposed Scheme</p> <p>The preferred solution for this crossing, taking account of engineering and environmental design criteria, is to replace the existing culvert with a revised gradient to accommodate the proposed scheme.</p> <p>The proposed scheme will require an earthwork 'cut' into the adjacent hillside to win space to accommodate the new southbound carriageway and the new adjacent side road. A new culvert inlet is proposed at the edge of the upstream road verge and a separate new culvert is also proposed to pass beneath the new side road thereby reducing the length of culvert required.</p> <p>The proposed scheme will require the culvert invert level at its entrance to be set at a lower level than the existing channel bed level at this location. In addition, the channel gradient between the A9 and side road culverts and upstream of the culvert entrance will be steeper; hence a new cascade feature will be required to convey the flow of water to the side road culvert entrance and down to the new mainline culvert.</p> <p>Downstream, the existing channel is impacted by the proposed scheme footprint. To accommodate the proposed scheme, the downstream watercourse will be realigned at a similar gradient and bed level, running over approximately 270m South, parallel to the toe of the new northbound embankment and will tie-in to the new WF42 culvert invert level.</p> <p>Environmental</p> <p>Ecological assessment has identified this watercourse as being an active mammal corridor and consequently there is a requirement to provide mammal passage. To facilitate this, a box culvert will be provided with mammal ledges set at the appropriate level.</p> |

| Waterbody | Culvert number & Location | Construction detail | Justifications for engineering solution |
|--|--|---|---|
| | | | <p>The invert of the new culvert will be buried to maintain continuity of the culvert invert gradient and natural bed material.</p> <p>Flood Risk</p> <p>The existing culvert freely passes the design flood event i.e. 0.5%AEP (200-year) change with 0.7m flood freeboard. Consequently, the existing A9 is not considered to be at flood risk during the design flood event.</p> <p>The new culvert arrangement will also freely pass the combined design flood event of both WF47 and WF49 with 0.80m culvert freeboard. The head water level at the culvert entrance is predicted to increase by 0.02m, despite the increase in size to a box culvert, as a result of combining flow from WF47 and WF49.</p> <p>The available freeboard between headwater level and the proposed A9 road level is 2.42m, hence the proposed scheme is not considered to be at flood risk during design flood event. As the head water level is contained within the upstream channel, no further mitigation measures are considered necessary.</p> <p>Downstream flood risk is not impacted by the proposed scheme.</p> |
| <p>WF49</p> <p>Approximate channel bed width at mainline culvert inlet: 1.2m</p> <p>Flow data: 50% AEP: 0.35m³/s 1% AEP: 0.45m³/s 0.5% AEP + CC: 0.62m³/s</p> | <p>49/A9</p> <p>Grid Reference: 299113, 750670</p> | <p>Removal of existing culvert and diversion of the watercourse to its confluence with WF47 upstream of A9.</p> <p>Abandonment of existing culvert beneath A9.</p> <p>Existing A9 culvert to be abandoned: Diameter = 1.0m Length = 14.9m</p> | <p>Watercourse WF49 is culverted beneath the existing A9 via a 0.90m diameter concrete culvert. The downstream channel passes through a private property to the downstream confluence with WF47.</p> <p>The proposed scheme will result in the A9 footprint at this location being widened on the upstream side (southbound carriageway) to accommodate the proposed scheme and adjacent side road. A number of alternative options have been considered, as follows:</p> <ul style="list-style-type: none"> Retain the existing culvert unchanged: The existing culvert is not long enough to accommodate the proposed scheme. Extension of the existing culvert: The existing culvert could be extended to accommodate the footprint of the proposed scheme, however this will not resolve the conflicts between culvert infrastructure and proposed scheme levels, and retaining wall in the northbound verge. Replacement of the existing culvert: A replacement culvert could be arranged to pass beneath the proposed mainline and side road. This will require re-grading the culvert invert level along its full length and would impact upon the private property downstream. Diversion of watercourse: <p>The preferred solution is to divert the alignment of the watercourse to run parallel to the proposed scheme upstream of the proposed scheme to a new confluence with water feature WF47. This solution avoids any conflict with the proposed scheme design and prevents any impact to the private property downstream.</p> <p>Proposed Scheme</p> <p>The preferred approach for this crossing taking account of engineering and environmental design criteria is to abandon the existing culvert and divert the watercourse to a new confluence with WF47 approximately 80m upstream of the existing confluence location.</p> <p>The watercourse will be realigned along this length (approximately 85m). The existing culvert will be abandoned and removed as part of the proposed scheme.</p> |

| Waterbody | Culvert number & Location | Construction detail | Justifications for engineering solution |
|---|--|--|--|
| | | | <p>Environmental</p> <p>There is no provision for mammal passage in the existing culvert. Ecological assessment has identified this watercourse as a potential mammal corridor; however, the removal of the culvert in this location inhibits any provision for mammal passage or natural bed material.</p> <p>Flood Risk</p> <p>Realigning the watercourse from the confluence with WF47 to the existing channel 80m upstream will result in an increase in flood risk to a short reach of the WF47. Given that no flood risk sensitive receptors exist along this short reach no further mitigation measures are being considered. Downstream of the existing confluence location the flood risk impact is considered to be negligible.</p> |
| | <p>49/US</p> <p>Grid Reference: 299141, 750670</p> | <p>New side road culvert.</p> <p>Proposed diameter = 1.05m</p> <p>Proposed length = 11.7m</p> <p>Proposed embedment = 0.15m</p> | <p>A new culvert is required upstream of the confluence with WF47 to accommodate the proposed realignment of the existing non-motorised user side road. Watercourse WF49 does not currently cross the existing side road, however, the realignment of WF49 to tie-in with WF47 and the realignment of the side road will conflict.</p> <p>The proposed new culvert has been designed to pass the 0.5% AEP (200-year) design flood event with appropriate freeboard due to its location above the A9 road level.</p> <p>Ecological assessment has identified this watercourse as a potential mammal corridor. Due to the (infrequent, non-motorised user) nature of the traffic using the side road the risk to mammals crossing overland in times of high river flow within the culvert barrel is not considered to be significant. Hence no provision of mammal ledges etc. within the new culvert section is proposed.</p> <p>The invert of the new culvert will be buried to maintain continuity of the culvert invert gradient and natural bed material.</p> |
| <p>WF50</p> <p>Approximate channel bed width at mainline culvert inlet: 1.4m</p> <p>Flow data: 50% AEP: 0.59m³/s 1% AEP: 0.75m³/s 0.5% AEP + CC: 1.04m³/s</p> | <p>50/A9</p> <p>Grid Reference: 298887, 750987</p> | <p>Replacement of existing A9 culvert with new culvert, on new alignment, including gradient change via manhole on road verge.</p> <p>Realignment of channel upstream of the culvert inlet and downstream of the culvert outlet.</p> <p>Existing diameter = 0.45m</p> <p>Existing length = 37.9m</p> <p>Proposed diameter = 1.4m</p> <p>Proposed length = 55.3m</p> <p>Proposed embedment = 0.2m</p> | <p>Watercourse WF50 is culverted beneath the existing A9 via a 0.45m diameter concrete culvert. The proposed scheme will result in the A9 footprint at this location being widened on the upstream side (southbound carriageway) to accommodate the proposed scheme including a new adjacent side road. The widening of the A9 footprint impacts the location of the existing culvert inlet.</p> <p>To accommodate the proposed scheme, a number of alternative watercourse crossing options have been considered, as follows:</p> <ul style="list-style-type: none"> Retain the existing culvert unchanged: The existing culvert is not long enough to accommodate the proposed scheme. Extension of the existing culvert: The existing culvert could be extended to accommodate the footprint of the proposed scheme, however this will not resolve the conflicts between culvert infrastructure and proposed scheme road and drainage levels as well as the proposed retaining wall at the side road junction. Resolving these conflicts will require elevating the proposed scheme road surface and drainage levels and removal of the retaining wall to accommodate the existing culvert infrastructure. This would have a significant impact in terms of increasing the footprint of the road, drainage design, visual impact and also contribute to increased capital cost. Replace the existing culvert: This is the preferred option: that the culvert will be replaced by a new alignment to accommodate the proposed scheme. |

| Waterbody | Culvert number & Location | Construction detail | Justifications for engineering solution |
|---|--|---|--|
| | | | <p>Proposed Scheme</p> <p>The preferred solution for this crossing, taking account of engineering and environmental design criteria, is to replace the existing culvert with a new culvert to accommodate the proposed scheme. The proposed new culvert will have a larger internal diameter, following a new plan alignment and gradient from the existing culvert.</p> <p>The proposed scheme will require an earthwork 'cut' into the adjacent hillside with a retaining wall, to win space to accommodate the new southbound carriageway. The vertical retaining wall will pass through the existing upstream channel.</p> <p>To convey flow through the retaining wall, the new culvert will have a change in gradient at a manhole, located in the verge between the retaining wall and the new southbound carriageway. The proposed culvert inlet will be located upstream of the retaining wall on the adjacent hillside and will pass through the retaining wall to the manhole, the culvert will then pass beneath the proposed A9 mainline to the new outlet location on the downstream (northbound) side.</p> <p>To accommodate the proposed culvert invert levels, it is proposed to realign the upstream watercourse over approximately 35m from the new culvert inlet to tie-in with the existing upstream channel bed level.</p> <p>To accommodate the proposed culvert outlet location, it is proposed to realign the downstream watercourse over approximately 470m, parallel to the toe of the new northbound embankment and side road. This new diversion will tie-in to the bed level of the new WF47 downstream channel realignment.</p> <p>Environmental</p> <p>There is no provision for mammal passage in the existing culvert. Ecological assessment has not identified this watercourse as a potential mammal corridor, hence no provision of mammal ledges etc. within the existing and extended culvert sections is proposed. An alternative mammal crossing has been established via a DMU at approx. 7800m chainage, with connection between corridors provided via mammal fencing.</p> <p>The invert of the new culvert will be buried to maintain continuity of the culvert invert gradient and natural bed material .</p> <p>Flood Risk</p> <p>The existing culvert is surcharged under the design flood event i.e. 0.5%AEP (200-year) plus an allowance for climate change. The water level at the inlet surcharges the culvert soffit by 5.45m, and it's likely that this will result in overland flow and flooding of the existing A9 road.at this location.</p> <p>The new culvert arrangement will freely pass the design flood event, with 0.51m culvert freeboard during the 0.5% AEP (200-year) design fluvial event. The head water depth at the culvert entrance is predicted to decrease by 5.16m as a result of the proposed culvert arrangement.</p> <p>Downstream flood risk is impacted by the proposed scheme, as the larger culvert barrel no longer throttles the design flow upstream and additional flow is introduced from the pre-earthwork diversion of WF51. There is a location of proposed floodplain compensation area immediately downstream of the A9 in this location, meaning that when the watercourse has insufficient capacity, flood waters spill into the compensation area. This area is designed to drain naturally, resulting in an increase in flood risk downstream of the compensation area due to the increased flows. The increase in flood depth is negligible (approximately 3mm) immediately downstream of the compensation area when compared to flood depths from a similar design event on the River Tay. As such, no further mitigation measures are considered necessary.</p> |
| <p>WF52</p> <p>Approximate channel bed width at mainline</p> | <p>52/A9/1 52/A9/2 52/A9/3</p> | <p>Replacement of existing A9 culvert including culvert network upstream.</p> | <p>Watercourse WF52 is culverted beneath the existing A9 via a 0.6m diameter concrete culvert. The proposed scheme will result in the A9 footprint at this location being widened on the upstream side (southbound carriageway) to accommodate the proposed scheme and the adjacent side road.</p> <p>To accommodate the proposed scheme, a number of alternative watercourse crossing options have been considered, as</p> |

| Waterbody | Culvert number & Location | Construction detail | Justifications for engineering solution |
|--|--|--|---|
| <p>culvert inlet: 0.8m</p> <p>Flow data: 50% AEP: 0.39m³/s 1% AEP: 0.49m³/s 0.5% AEP + CC: 0.69m³/s</p> | <p>52/A9/4 52/A9/5</p> <p>Grid Reference: 298635, 751461</p> | <p>Existing diameter = 0.59m Existing length = 37.9m</p> <p>Proposed diameter 1 = 1.05m Proposed diameter 2 = 0.75m Proposed diameter 3 = 1.05m Proposed diameter 4 = 1.05m Proposed diameter 5 = 0.75m</p> <p>Proposed length 1 = 50.6m Proposed length 2 = 7.1m Proposed length 3 = 49.5m Proposed length 4 = 30.7m Proposed length 5 = 14.8m</p> <p>Proposed embedment (all) = 0.15m</p> | <p>follows:</p> <ul style="list-style-type: none"> Retain the existing culvert unchanged: The existing culvert is not long enough to accommodate the proposed scheme. Extension of the existing culvert: The existing culvert cannot be extended to accommodate the footprint of the proposed scheme, as currently 3 watercourses converge upstream of the existing A9 and are conveyed downstream via a single culvert. The proposed scheme footprint conflicts with the alignment and confluences of the three watercourses. Replace the existing culvert: This is the preferred option: that the culvert will be replaced with a new alignment with a network of upstream pipes to accommodate the proposed scheme. <p>Proposed Scheme</p> <p>The preferred solution for this crossing taking account of engineering and environmental design criteria is to replace the existing culvert with a new culvert to accommodate the proposed scheme.</p> <p>The proposed new culvert will consist of a network of five pipes, set at a lower level and gradient, with a larger internal diameter connected via by a series of manholes. The proposed new culverts will convey flow from each of the three watercourses located upstream of the scheme and converge these watercourses into a single culvert to pass flow downstream.</p> <p>To accommodate the proposed culvert invert levels, it is proposed to locally regrade the watercourses upstream of culvert inlets.</p> <p>To accommodate the proposed culvert invert levels, it is proposed to regrade the downstream watercourse over approximately 50m from the new culvert outlet to tie-in with the existing downstream channel bed level.</p> <p>Environmental</p> <p>There is no provision for mammal passage in the existing culvert. Ecological assessment has not identified this watercourse as a potential mammal corridor, hence no provision of mammal ledges etc. within the existing and extended culvert sections is proposed. An alternative mammal crossing has been established via a dry mammal underpass at approx. chainage 7800m with connection between corridors provided via mammal fencing.</p> <p>The culvert invert is specified to be embedded through the proposed culvert extension to maintain continuity of the culvert invert gradient and natural bed material.</p> <p>Flood Risk</p> <p>The existing culvert is surcharged under the design flood event i.e. 0.5%AEP (200-year) plus an allowance for climate change. The water level at the inlet surcharges the culvert soffit by 0.63m, with peak water level outwith the banks of the upstream channel. Freeboard to the existing A9 road level is 1.21m, consequently the existing A9 is not considered to be at flood risk during the design flood event.</p> <p>The new culvert arrangement will also freely pass the design flood event with a range of culvert freeboards in each pipe during the 0.5% AEP (200-year) design fluvial event, as follows:</p> <ul style="list-style-type: none"> Culvert freeboard in 52/A9/1 pipe = 0.23m Culvert freeboard in 52/A9/2 pipe = 0.28m |

| Waterbody | Culvert number & Location | Construction detail | Justifications for engineering solution |
|--|---|---|---|
| | | | <ul style="list-style-type: none"> • Culvert freeboard in 52/A9/3 pipe = 0.30m • Culvert freeboard in 52/A9/4 pipe = 0.28m • Culvert freeboard in 52/A9/5 pipe = 0.38m <p>The head water depth is predicted to decrease at each culvert entrance (minimum 0.55m) as a result of upsizing of the culverts, and the new inlet locations collecting inflows individually and combining flows within the network.</p> <p>The available freeboard between headwater level and the proposed A9 road level is predicted to be at minimum 0.94m at the inlet to pipe 52/A9/5, hence the proposed scheme is not considered to be at flood risk during design flood event. As the head water level is contained within the upstream channel, no upstream mitigation measures are considered necessary.</p> <p>Downstream flood risk is impacted by the proposed scheme, as the larger culvert barrel no longer throttles the design flow upstream. The 0.37m³/s increase in peak flow at WF52 causes extensive flooding to the fields downstream of the A9. The flooding downstream is however generally in the same areas and at a reduced depth when compared to flood depths from a similar design event on the River Tay. As such, further assessment is considered necessary with mitigation measures to be further developed at specimen and detail design stage.</p> |
| <p>WF53</p> <p>Approximate channel bed width at mainline culvert inlet: 2.3m</p> <p>Flow data: 50% AEP: 0.28m³/s 1% AEP: 0.36m³/s 0.5% AEP + CC: 0.49m³/s</p> | <p>53/A9</p> <p>Grid Reference: 298381, 751677</p> | <p>Replacement of existing A9 culvert with new culvert.</p> <p>Local regrading of channel upstream of the culvert inlet.</p> <p>Existing diameter = 1.15m Existing length = 42.1m</p> <p>Proposed diameter = 1.20m Proposed Length = 42.1m Proposed embedment = 0.3m</p> | <p>Watercourse WF53 is culverted beneath the existing A9 via a 1.15m diameter concrete culvert. The proposed scheme will result in the A9 footprint at this location being widened on the upstream side (southbound carriageway) to accommodate the proposed scheme.</p> <p>To accommodate the proposed scheme, a number of alternative watercourse crossing options have been considered, as follows:</p> <ul style="list-style-type: none"> • Retain the existing culvert unchanged: The existing culvert is long enough to accommodate the proposed scheme, however, the existing culvert infrastructure is insufficient for the management of flood risk from the River Tay. • Extension of the existing culvert: The existing culvert is long enough to accommodate the proposed scheme, however, the existing culvert infrastructure is insufficient for the management of flood risk from the River Tay. Resolving the conflicts will require increase of the existing culvert diameter. • Replace the existing culvert: This is the preferred option: that the culvert will be replaced on a new plan alignment to accommodate the management of flood risk for the proposed scheme. <p>Proposed Scheme</p> <p>The preferred solution for this crossing taking account of engineering and environmental design criteria is to replace the existing culvert to accommodate the proposed scheme. The proposed new culvert will have a larger internal diameter, following a new plan alignment from the existing culvert.</p> <p>To accommodate the proposed new culvert inlet location, it is proposed to regrade the upstream watercourse locally from the new culvert inlet to tie-in with the existing upstream channel bed levels.</p> <p>Environmental</p> <p>There is no provision for mammal passage in the existing culvert. Ecological assessment has not identified this watercourse</p> |

| Waterbody | Culvert number & Location | Construction detail | Justifications for engineering solution |
|--|---|---|--|
| | | | <p>as a potential mammal corridor, hence no provision of mammal ledges etc. within the existing and extended culvert sections is proposed. An alternative mammal crossing has been established via a DMU at approx. 8260m chainage, with connection between corridors provided via mammal fencing.</p> <p>The culvert invert is specified to be embedded through the proposed culvert extension to maintain continuity of the culvert invert gradient and natural bed material.</p> <p>Flood Risk</p> <p>The existing culvert freely passes the design flood event i.e. 0.5%AEP (200-year) plus an allowance for climate change, with 0.59m flood freeboard. Consequently, the existing A9 is not considered to be at flood risk during the design flood event.</p> <p>The new culvert arrangement will also freely pass the design flood event with 0.42m culvert freeboard during the 0.5% AEP (200-year) design fluvial event. The head water depth at the culvert entrance is predicted to decrease by 0.04m as a result of the larger culvert size.</p> <p>The available freeboard between headwater level and the proposed A9 road level is predicted to be 2.29m, hence the proposed scheme is not considered to be at flood risk during design flood event. As the head water level is contained within the upstream channel, no upstream mitigation measures are considered necessary.</p> <p>Upstream flood risk is impacted by the proposed scheme as widening of the upstream side (southbound carriageway) results in the partial loss of upstream floodplain. The existing culvert freely passes the design flood event for WF53; however, in the event of flooding on the River Tay the loss of floodplain has an adverse impact on the upstream peak flood levels. For this reason, the diameter of the culvert has been upsized to limit impact on peak flood level to a negligible amount. Flood passage between upstream and downstream catchments are detailed further in Appendix A11.3 (Flood Risk Assessment)</p> <p>Downstream flood risk is not impacted by the proposed scheme.</p> |
| <p>WF55</p> <p>Approximate channel bed width at mainline culvert inlet: 1.5m</p> <p>Flow data: 50% AEP: 0.49m³/s 1% AEP: 0.62m³/s 0.5% AEP + CC: 0.88m³/s</p> | <p>55/A9</p> <p>Grid Reference: 298090, 751831</p> | <p>No changes are proposed to existing A9 mainline culvert.</p> | <p>The watercourse is culverted beneath the already dualled section of the A9 mainline in Ballinluig. The proposed scheme does not extend this far into Ballinluig and as such no constructions works are proposed at any location along this watercourse.</p> <p>Proposed Scheme</p> <p>The existing culvert is adequate to accommodate the proposed scheme at this location.</p> <p>Environmental</p> <p>No change to the existing culvert and local watercourse is proposed.</p> <p>Flood risk</p> <p>No change to existing flood risk is anticipated</p> |

4 Photographs

4.1.1 Photographs of each of the culverts and watercourses are provided in Table 2. Typically, where available, both upstream and downstream photographs are provided to illustrate smaller structures. Larger structures e.g. bridges typically are provided with a single representative view.

Table 2: Watercourse photographs

| | |
|---|--|
| | |
| <p>Photograph 1 WF18 Existing A9 culvert outlet and downstream channel</p> | <p>Photograph 2 WF18 Existing A9 culvert inlet and upstream channel</p> |



Photograph 3

WF19 Existing A9 culvert outlet and downstream channel



Photograph 4

WF19 Existing A9 culvert inlet and upstream channel



Photograph 5

WF20 Existing A9 culvert outlet and downstream channel



Photograph 6

WF20 Existing A9 culvert inlet and upstream channel



Photograph 7

WF21 Existing A9 culvert inlet and upstream channel



Photograph 8

WF23 Existing A9 culvert outlet and downstream channel



Photograph 9

WF24 Existing A9 culvert outlet and downstream channel



Photograph 10

WF24 Existing A9 culvert inlet and upstream channel



Photograph 11

WF25 Existing A9 culvert outlet and downstream channel



Photograph 12

WF25 Existing A9 culvert inlet and upstream channel



Photograph 13

WF28 Existing A9 culvert outlet and downstream channel



Photograph 14

WF28 Existing A9 culvert inlet and upstream channel



Photograph 15

WF29 Existing A9 culvert outlet and downstream channel



Photograph 16

WF29 Existing A9 culvert inlet and upstream channel



Photograph 17

WF30 Existing A9 culvert outlet and downstream channel



Photograph 18

WF30 Existing A9 culvert inlet and upstream channel



Photograph 19

WF31 Existing A9 culvert outlet and downstream channel



Photograph 20

WF31 Existing A9 culvert inlet and upstream channel



Photograph 21

WF32 Existing A9 culvert outlet and downstream channel



Photograph 22

WF32 Existing A9 culvert inlet and upstream channel



Photograph 23

WF33 Existing A9 culvert outlet and downstream channel



Photograph 24

WF33 Existing A9 culvert inlet and upstream channel



Photograph 25

WF34 Existing A9 culvert outlet and downstream channel



Photograph 26

WF34 Existing A9 culvert inlet and upstream channel



Photograph 27

WF35 Existing A9 culvert outlet and downstream channel



Photograph 28

WF35 Existing A9 culvert inlet and upstream channel



Photograph 29

WF36 Existing A9 culvert outlet and downstream channel



Photograph 30

WF36 Existing A9 culvert inlet and upstream channel



Photograph 31

WF37 Existing A9 culvert outlet and downstream channel



Photograph 32

WF37 Existing A9 culvert inlet and upstream channel



Photograph 33

WF38 Existing A9 culvert outlet and downstream channel



Photograph 34

WF39 Existing A9 culvert outlet and downstream channel



Photograph 35

WF39 Existing A9 culvert inlet and upstream channel



Photograph 36

WF40 Existing A9 culvert outlet and downstream channel



Photograph 37

WF40 Existing A9 culvert inlet and upstream channel



Photograph 38

WF41 Existing A9 culvert outlet and downstream channel



Photograph 39

WF41 Existing A9 culvert inlet and upstream channel



Photograph 40

WF42 Existing A9 culvert outlet and downstream channel



Photograph 41

WF42 Existing A9 culvert inlet and upstream channel



Photograph 42

WF47 Existing A9 culvert outlet and downstream channel



Photograph 43

WF47 Existing A9 culvert inlet and upstream channel



Photograph 44

WF49 Existing A9 culvert outlet and downstream channel



Photograph 45

WF49 Existing A9 culvert inlet and upstream channel



Photograph 46

WF50 Existing A9 culvert outlet and downstream channel



Photograph 47

WF50 Existing A9 culvert inlet and upstream channel



Photograph 48

WF52 Existing A9 culvert outlet and downstream channel



Photograph 49

WF52 Existing A9 culvert inlet and upstream channel



Photograph 50

WF53 Existing A9 culvert outlet and downstream channel



Photograph 51

WF53 Existing A9 culvert inlet and upstream channel

5 References

The Highways Agency, Scottish Government, Welsh Assembly Government and The Department for Regional Development Northern Ireland (2001). Design Manual for Roads and Bridges Volume 10, Section 4, Part 4, HA 81/99 Environmental design and management. Nature conservation. Nature conservation advice in relation to otters. Available at: [DMRB Vol. 10, Section 4, Part 4, HA81/99](#)

The Highways Agency, Scottish Government, Welsh Assembly Government and The Department for Regional Development Northern Ireland (2012). Design Manual for Roads and Bridges Volume 3, Section 4, Part 21, BD 97/12 Highway Structures: Inspection and Maintenance. Assessment. Assessment of scour and other hydraulic action at highway structures. Available at: [DMRB Vol. 3, Section 4, Part 21 BD97/12](#)

SEPA (2008). Engineering in the water environment: good practice guide: Bank Protection (WAT-SG-23), First Edition (April 2008). Available at: https://www.sepa.org.uk/media/150971/wat_sg_23.pdf

SEPA (2010). Engineering in the water environment: good practice guide: Sediment Management (WAT-SG-26), First Edition (June 2010). Available at: <https://www.sepa.org.uk/media/151049/wat-sg-26.pdf>

SEPA and Natural Scotland (2010). Engineering in the water environment: good practice guide: River Crossings (WAT-SG-25), Second Edition (November 2010). Available at: <https://www.sepa.org.uk/media/151036/wat-sg-25.pdf>

6 Drawings

- 6.1.1 Engineering sketches (and where available, drawings) are provided for each watercourse crossing. Sketches outlining the proposed arrangements are provided for the numerous smaller watercourse crossings which are proposed to be replaced or extended to accommodate the widened A9 footprint. General Arrangement drawings of the larger structures are provided, which present a greater level of detail for these structures.

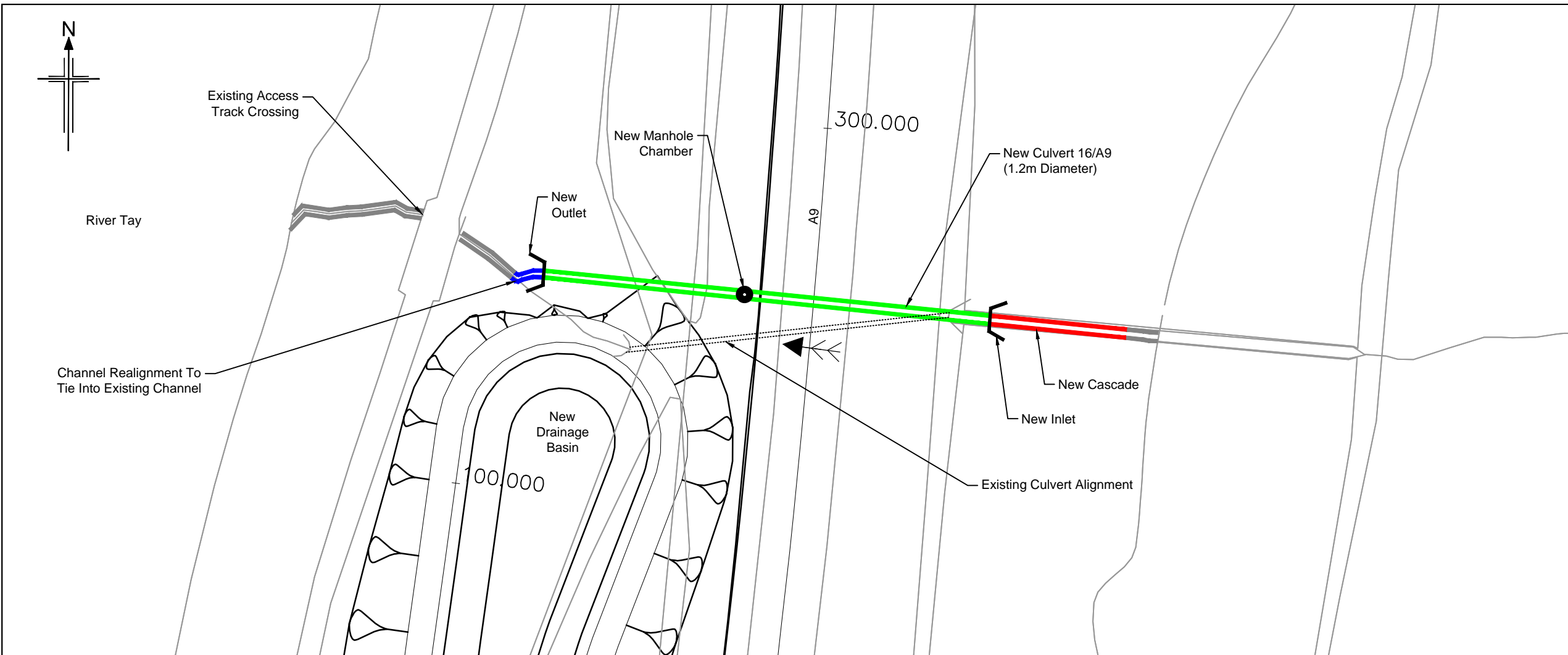

- Legend:
- New culvert/extension
 - - - Retained culvert
 - Realigned/reggraded channel
 - Cascade
 - Inlet/outlet headwall (new)
 - Inlet/outlet headwall (retained)
 - Pre-earthworks drain and outfall
 - Access chamber
 - Flow direction
 - Invert Level

- Notes:
1. All dimensions are in meters unless noted otherwise.
 2. All levels are in meters above ordnance datum.
 3. All details shown on this drawing are indicative only and subject to further development at specimen design stage. NOT FOR CONSTRUCTION.
 4. This drawing shall be read in conjunction with the 'Watercourse Crossing report' only and not in isolation.
 5. All 'new' and 'extended' culverts have been designed in accordance with the relevant provisions of DMRB.
 6. Where required 'scour protection measures' shall be provided within the zone of scour influence as indicated on the drawing. The nature and the extent of the scour protection measure will be further developed at specimen design stage in accordance with the relevant provisions of DMRB and relevant Good Practice Guides, taking into account flow hydraulics, channel geometry and channel morphology. This may include the provision of scour pools / stilling basin appropriately designed on a site by site basis.
 7. Where shown culverts shall be 'embedded' with natural river deposits to the depth shown.
 8. Where shown 'cascades' are required to safely convey the design flood event (0.5% AEP (200-year) plus allowance for climate change). The cascade geometry shown on the drawing is indicative only and will be subject to further development at specimen design stage. The nature of the cascade will take one of the following general forms:
 - Bedrock channel cascade.
 - Natural cascade with natural gravels, cobbles and rock forming individual steps.
 - Concrete cascade with stone pitching.
 The nature of the cascade will be determined at the specimen design stage taking into account hydraulic requirements, topography and nature of the underlying strata and its susceptibility to fluvial erosion.
 9. Where shown mammal ledges will be provided within the culvert in accordance with the relevant provisions of DMRB.

SCHEMATIC PLAN

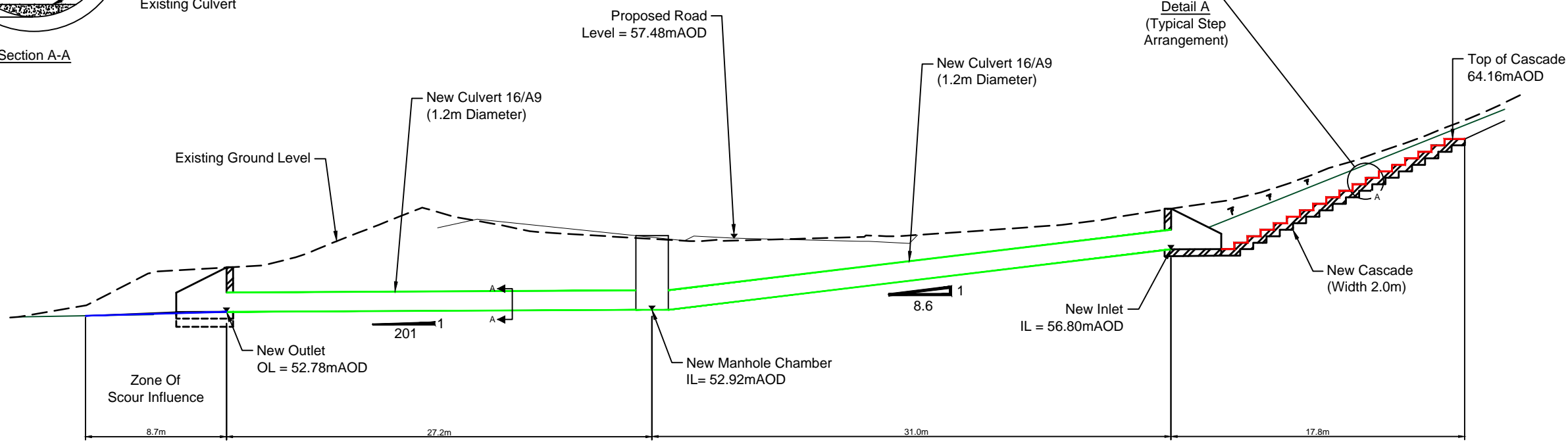
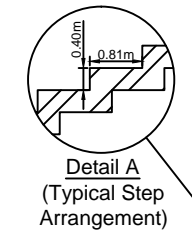
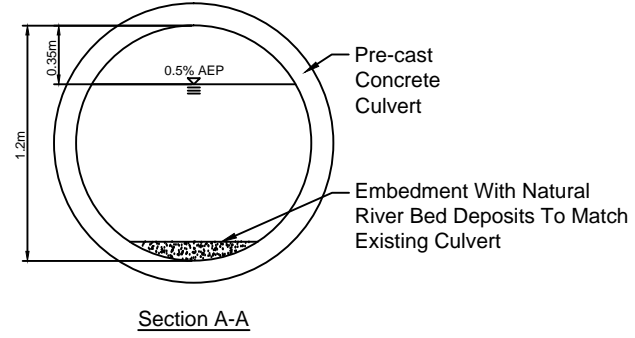

| 0 | 29/01/2018 | FOR INFORMATION | KL | KA | LMGG | |
|-----|------------|---------------------|-------|---------|-------|---------|
| Rev | Rev. Date | Purpose of revision | Drawn | Checked | Rev'd | Apprv'd |



Drawing title
**TAY CROSSING TO BALLINLUIG
 PROPOSED MODIFICATIONS
 TO CULVERT ON
 WATERCOURSE WF16**

Drawing status
FOR INFORMATION

Scale
 NTS @ A1 DO NOT SCALE

Jacobs No.
 B2140003

Drawing number
Figure A11.8.01

Reproduced by permission of Ordnance Survey on behalf of HMSO. © Crown copyright and database right 2017. All rights reserved. Ordnance Survey Licence number 100046668.

WATERCOURSE 16 LONGSECTION

© Copyright 2015 Jacobs U.K. Limited. The concepts and information contained in this document are the property of Jacobs. Use or copying of this document in whole or in part without the written permission of Jacobs constitutes an infringement of copyright. Limitation: This drawing has been prepared on behalf of, and for the exclusive use of, Jacobs' Client, and is subject to, and issued in accordance with, the provisions of the contract between Jacobs and the Client. Jacobs accepts no liability or responsibility whatsoever for, or in respect of, any use of, or reliance upon, this drawing by any third party.

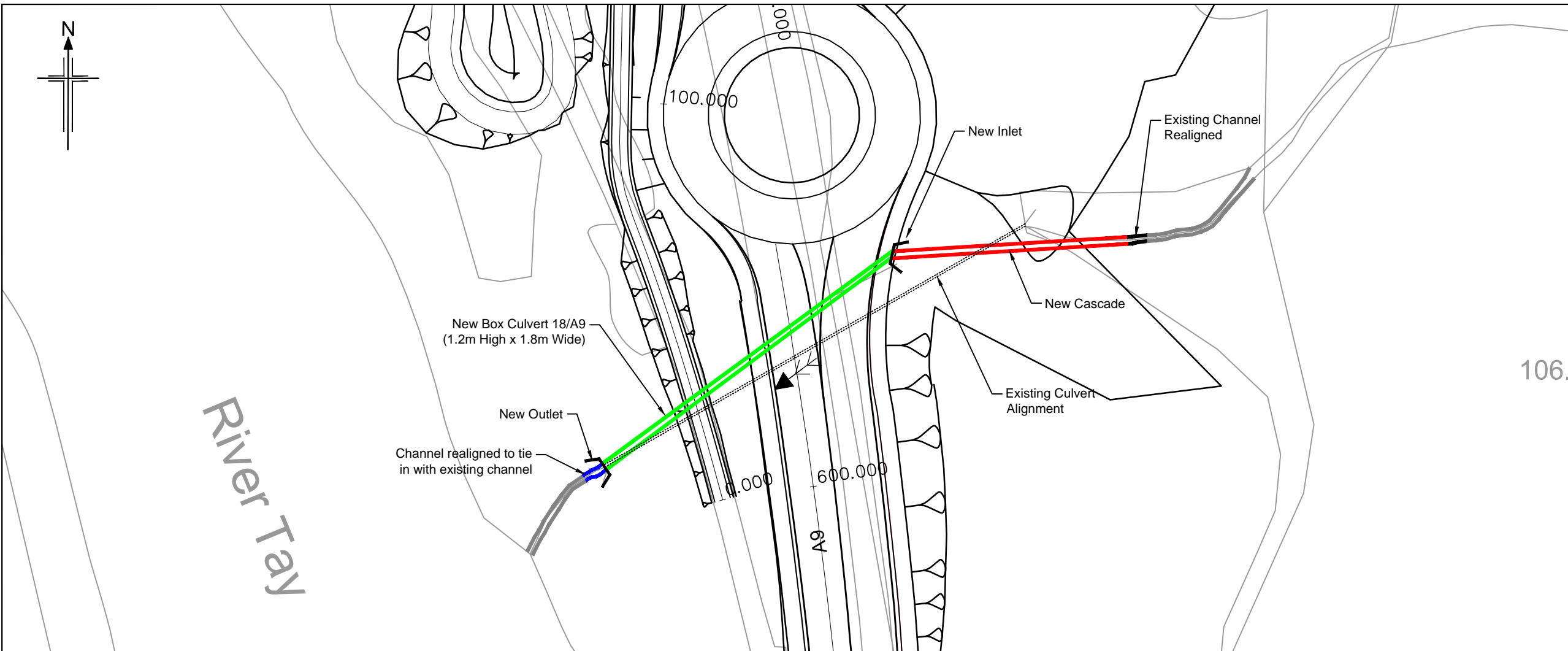

- Legend:
- New culvert/extension
 - Retained culvert
 - Realigned/regraded channel
 - Cascade
 - Inlet/outlet headwall (new)
 - Inlet/outlet headwall (retained)
 - Pre-earthworks drain and outfall
 - Access chamber
 - ← Flow direction
 - IL Invert Level

- Notes:
1. All dimensions are in meters unless noted otherwise.
 2. All levels are in meters above ordnance datum.
 3. All details shown on this drawing are indicative only and subject to further development at specimen design stage. NOT FOR CONSTRUCTION.
 4. This drawing shall be read in conjunction with the 'Watercourse Crossing report' only and not in isolation.
 5. All 'new' and 'extended' culverts have been designed in accordance with the relevant provisions of DMRB.
 6. Where required 'scour protection measures' shall be provided within the zone of scour influence as indicated on the drawing. The nature and the extent of the scour protection measure will be further developed at specimen design stage in accordance with the relevant provisions of DMRB and relevant Good Practice Guides, taking into account flow hydraulics, channel geometry and channel morphology. This may include the provision of scour pools / stilling basin appropriately designed on a site by site basis.
 7. Where shown culverts shall be 'embedded' with natural river deposits to the depth shown.
 8. Where shown 'cascades' are required to safely convey the design flood event (0.5% AEP (200-year) plus allowance for climate change). The cascade geometry shown on the drawing is indicative only and will be subject to further development at specimen design stage. The nature of the cascade will take one of the following general forms:
 - Bedrock channel cascade.
 - Natural cascade with natural gravels, cobbles and rock forming individual steps.
 - Concrete cascade with stone pitching.
 The nature of the cascade will be determined at the specimen design stage taking into account hydraulic requirements, topography and nature of the underlying strata and its susceptibility to fluvial erosion.
 9. Where shown mammal ledges will be provided within the culvert in accordance with the relevant provisions of DMRB.

SCHMATIC PLAN

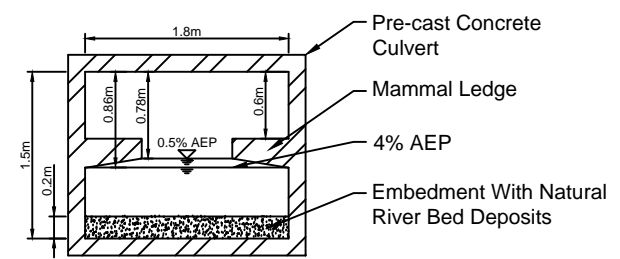

Section A-A

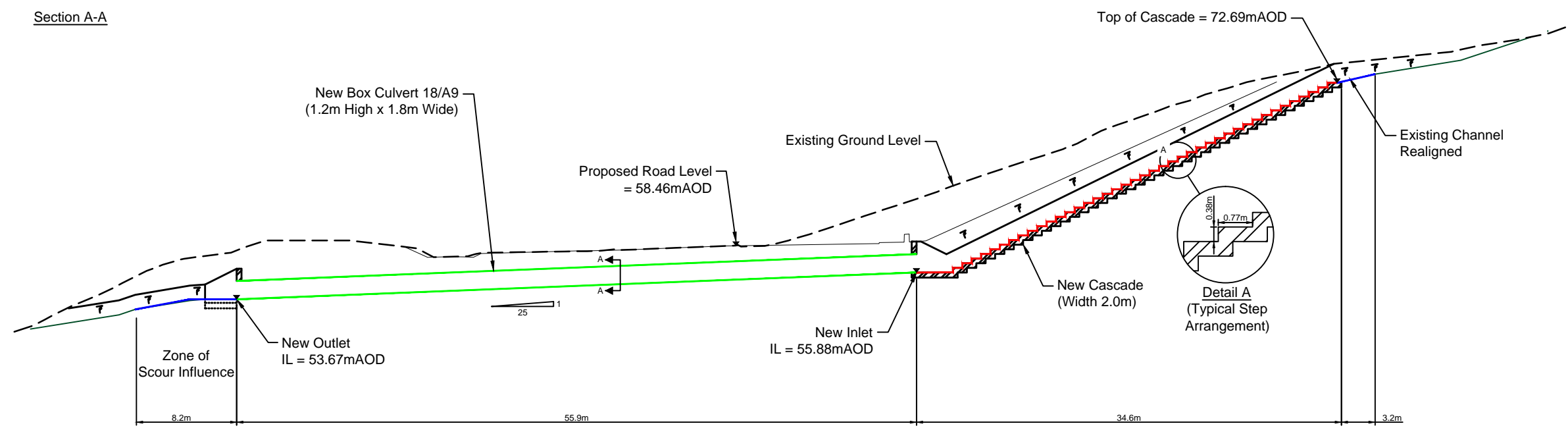

WATERCOURSE 18 LONGSECTION

| 0 | 29/01/2018 | FOR INFORMATION | KL | KA | LMGG | |
|-----|------------|---------------------|-------|---------|-------|---------|
| Rev | Rev. Date | Purpose of revision | Drawn | Checked | Rev'd | Apprv'd |

JACOBS
 85 Bothwell St, Glasgow, G2 7HX
 Tel: +44(0)141 243 8000 Fax: +44(0)141 226 3109
 www.jacobs.com



Drawing title
**TAY CROSSING TO BALLINLUIG
 PROPOSED MODIFICATIONS
 TO CULVERT ON
 WATERCOURSE WF18**

| | | |
|-----------------------------------|-----------------|--------------|
| Drawing status FOR INFORMATION | | |
| Scale | NTS @ A1 | DO NOT SCALE |
| Jacobs No. | B2140003 | |
| Drawing number | Figure A11.8.02 | Rev 0 |

Reproduced by permission of Ordnance Survey on behalf of HMSO. © Crown copyright and database right 2017. All rights reserved. Ordnance Survey Licence number 100046668.

© Copyright 2015 Jacobs U.K. Limited. This concepts and information contained in this document are the property of Jacobs. Use or copying of this document in whole or in part without the written permission of Jacobs constitutes an infringement of copyright. Limitation: This drawing has been prepared on behalf of, and for the exclusive use of Jacobs' Client, and is subject to, and issued in accordance with, the provisions of the contract between Jacobs and the Client. Jacobs accepts no liability or responsibility whatsoever for, or in respect of, any use of, or reliance upon, this drawing by any third party.

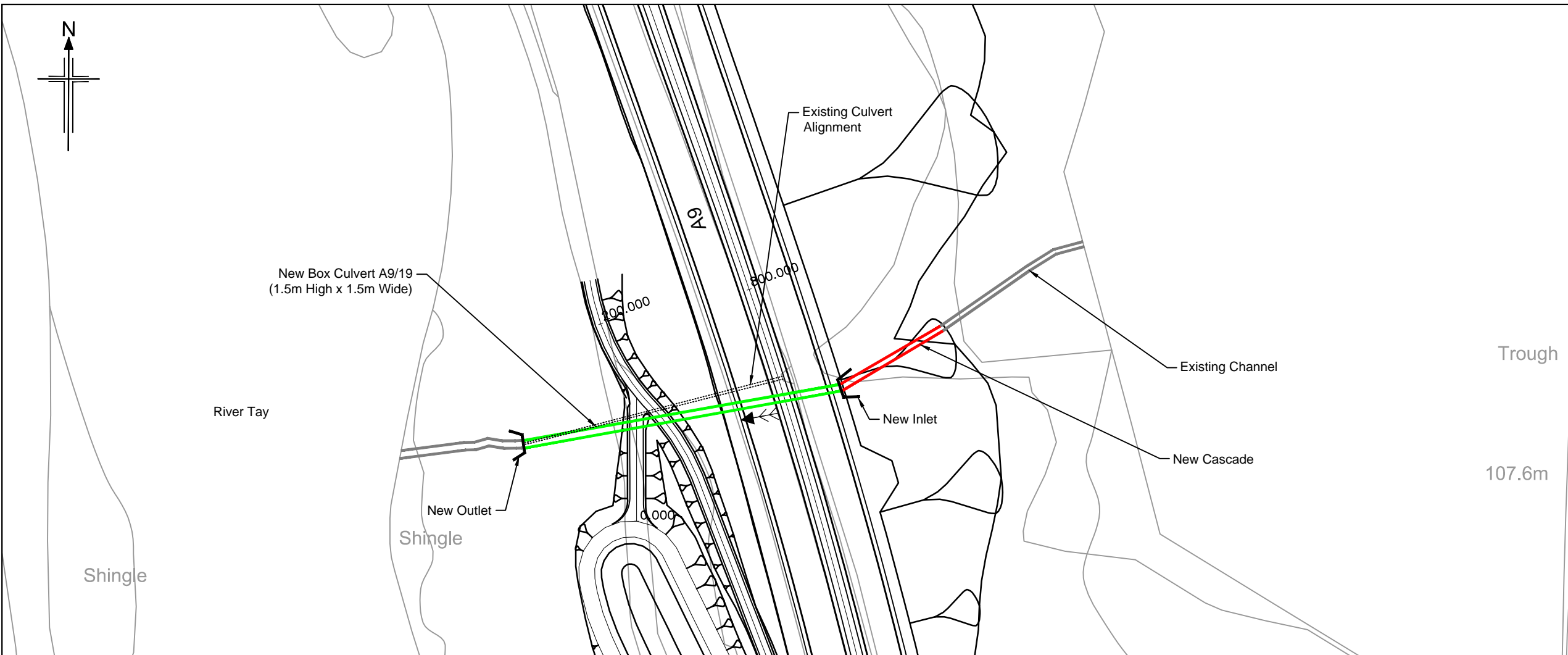

- Legend:
- New culvert/extension
 - Retained culvert
 - Realigned/regraded channel
 - Cascade
 - Inlet/outlet headwall (new)
 - Inlet/outlet headwall (retained)
 - Pre-earthworks drain and outfall
 - Access chamber
 - ← Flow direction
 - IL Invert Level

- Notes:
1. All dimensions are in meters unless noted otherwise.
 2. All levels are in meters above ordnance datum.
 3. All details shown on this drawing are indicative only and subject to further development at specimen design stage. NOT FOR CONSTRUCTION.
 4. This drawing shall be read in conjunction with the 'Watercourse Crossing report' only and not in isolation.
 5. All 'new' and 'extended' culverts have been designed in accordance with the relevant provisions of DMRB.
 6. Where required 'scour protection measures' shall be provided within the zone of scour influence as indicated on the drawing. The nature and the extent of the scour protection measure will be further developed at specimen design stage in accordance with the relevant provisions of DMRB and relevant Good Practice Guides, taking into account flow hydraulics, channel geometry and channel morphology. This may include the provision of scour pools / stilling basin appropriately designed on a site by site basis.
 7. Where shown culverts shall be 'embedded' with natural river deposits to the depth shown.
 8. Where shown 'cascades' are required to safely convey the design flood event (0.5% AEP (200-year) plus allowance for climate change). The cascade geometry shown on the drawing is indicative only and will be subject to further development at specimen design stage. The nature of the cascade will take one of the following general forms:
 - Bedrock channel cascade.
 - Natural cascade with natural gravels, cobbles and rock forming individual steps.
 - Concrete cascade with stone pitching.
 The nature of the cascade will be determined at the specimen design stage taking into account hydraulic requirements, topography and nature of the underlying strata and its susceptibility to fluvial erosion.
 9. Where shown mammal ledges will be provided within the culvert in accordance with the relevant provisions of DMRB.

SCHMATIC PLAN

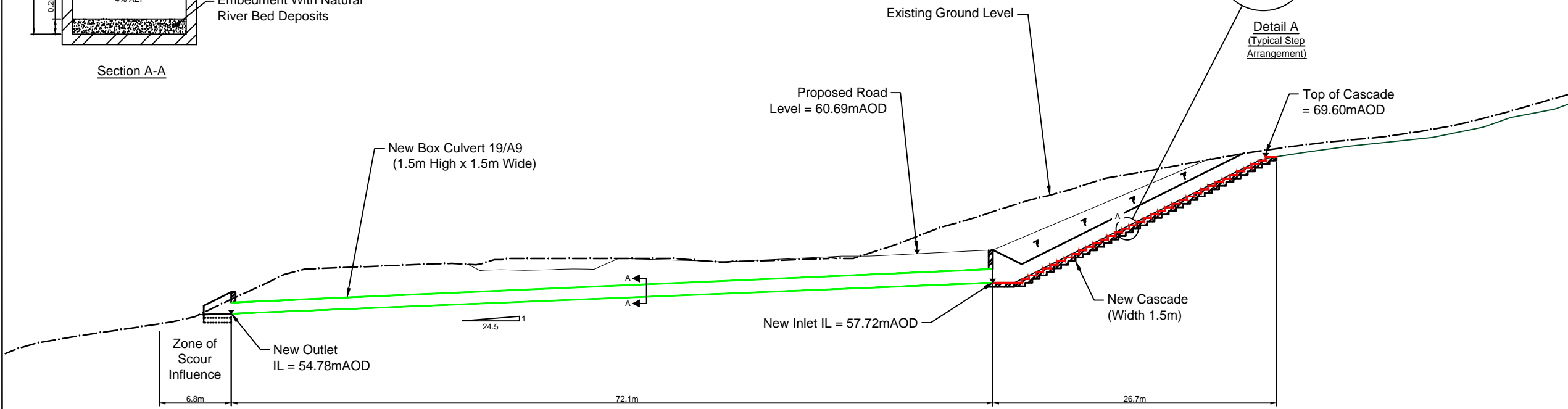
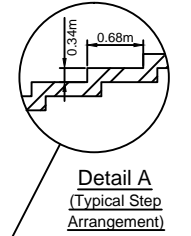
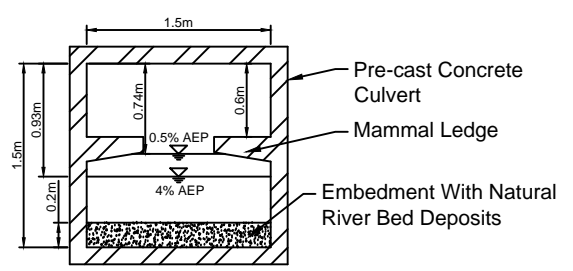

| 0 | 29/01/2018 | FOR INFORMATION | KL | KA | LMGG | |
|-----|------------|---------------------|-------|---------|-------|---------|
| Rev | Rev. Date | Purpose of revision | Drawn | Checked | Rev'd | Apprv'd |



Drawing title
**TAY CROSSING TO BALLINLUIG
 PROPOSED MODIFICATIONS
 TO CULVERT ON
 WATERCOURSE WF19**

| | | |
|-----------------------------------|-----------------|--------------|
| Drawing status FOR INFORMATION | | |
| Scale | NTS @ A1 | DO NOT SCALE |
| Jacobs No. | B2140003 | |
| Drawing number | Figure A11.8.03 | Rev 0 |

Reproduced by permission of Ordnance Survey on behalf of HMSO. © Crown copyright and database right 2017. All rights reserved. Ordnance Survey Licence number 100046668.

WATERCOURSE 19 LONGSECTION

© Copyright 2015 Jacobs U.K. Limited. The concepts and information contained in this document are the property of Jacobs. Use or copying of this document in whole or in part without the written permission of Jacobs constitutes an infringement of copyright. Limitation: This drawing has been prepared on behalf of, and for the exclusive use of, Jacobs' Client, and is subject to, and issued in accordance with, the provisions of the contract between Jacobs and the Client. Jacobs accepts no liability or responsibility whatsoever for, or in respect of, any use of, or reliance upon, this drawing by any third party.

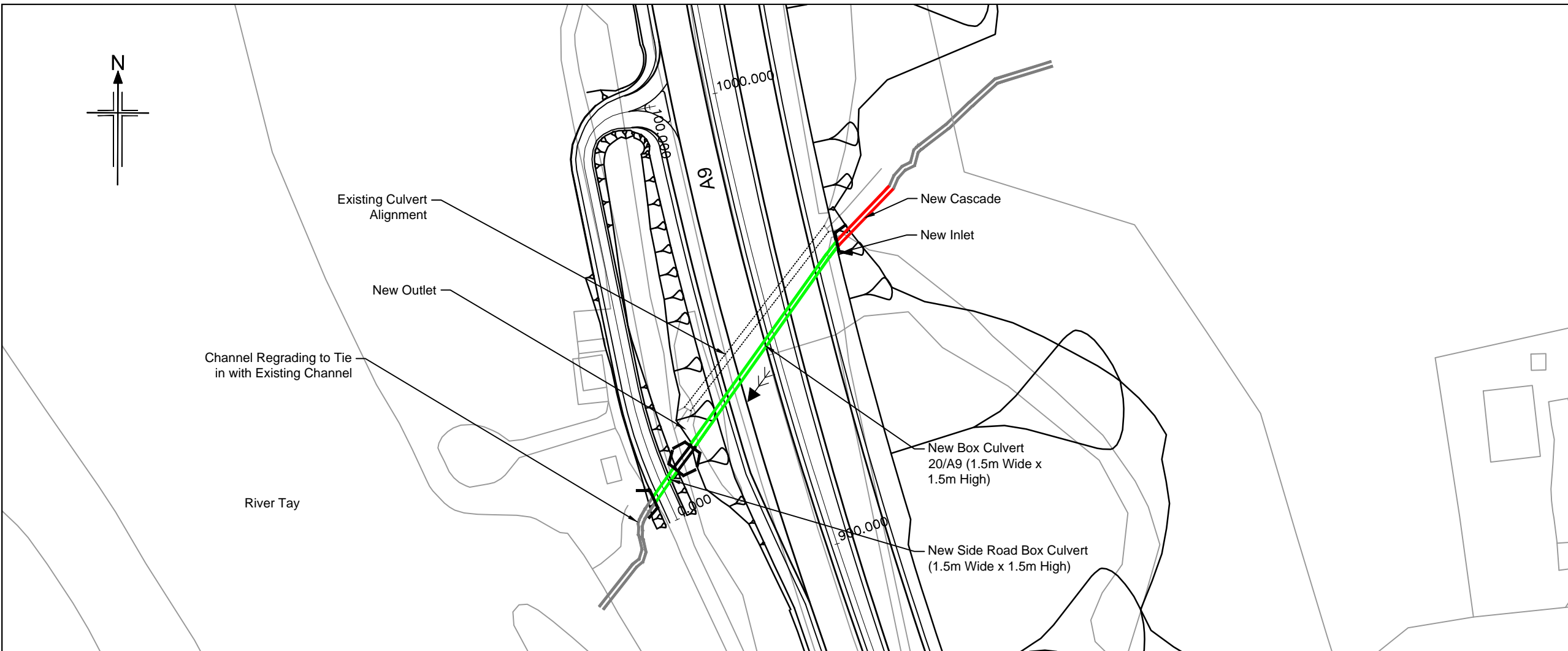

- Legend:
- New culvert/extension
 - Retained culvert
 - Realigned/regraded channel
 - Cascade
 - Inlet/outlet headwall (new)
 - Inlet/outlet headwall (retained)
 - Pre-earthworks drain and outfall
 - Access chamber
 - Flow direction
 - Invert Level

- Notes:
1. All dimensions are in meters unless noted otherwise.
 2. All levels are in meters above ordnance datum.
 3. All details shown on this drawing are indicative only and subject to further development at specimen design stage. NOT FOR CONSTRUCTION.
 4. This drawing shall be read in conjunction with the 'Watercourse Crossing report' only and not in isolation.
 5. All 'new' and 'extended' culverts have been designed in accordance with the relevant provisions of DMRB.
 6. Where required 'scour protection measures' shall be provided within the zone of scour influence as indicated on the drawing. The nature and the extent of the scour protection measure will be further developed at specimen design stage in accordance with the relevant provisions of DMRB and relevant Good Practice Guides, taking into account flow hydraulics, channel geometry and channel morphology. This may include the provision of scour pools / stilling basin appropriately designed on a site by site basis.
 7. Where shown culverts shall be 'embedded' with natural river deposits to the depth shown.
 8. Where shown 'cascades' are required to safely convey the design flood event (0.5% AEP (200-year) plus allowance for climate change). The cascade geometry shown on the drawing is indicative only and will be subject to further development at specimen design stage. The nature of the cascade will take one of the following general forms:
 - Bedrock channel cascade.
 - Natural cascade with natural gravels, cobbles and rock forming individual steps.
 - Concrete cascade with stone pitching.
 The nature of the cascade will be determined at the specimen design stage taking into account hydraulic requirements, topography and nature of the underlying strata and its susceptibility to fluvial erosion.
 9. Where shown mammal ledges will be provided within the culvert in accordance with the relevant provisions of DMRB.

SCHEMATIC PLAN

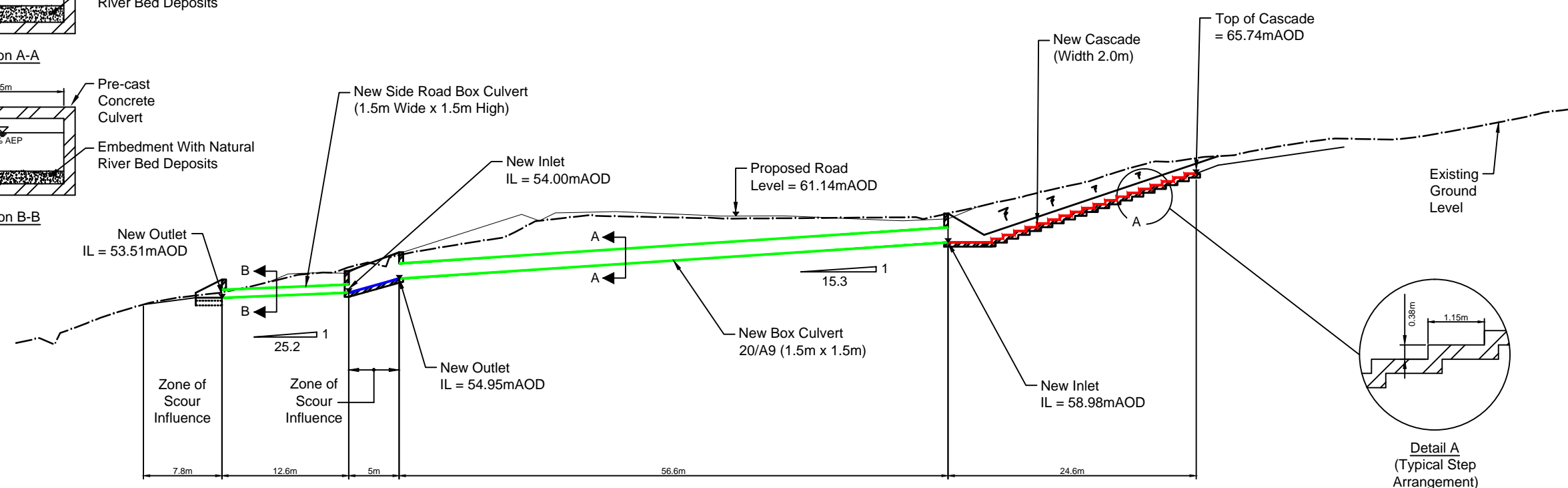
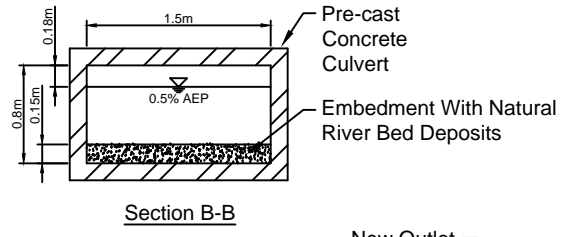
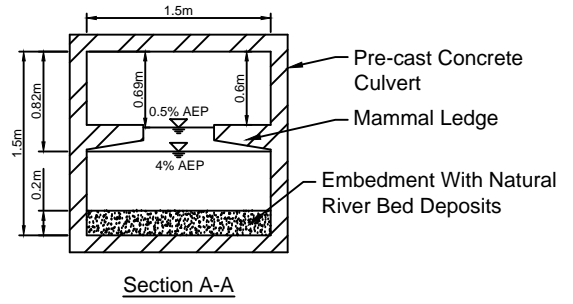

WATERCOURSE 20 LONGSECTION

| 0 | 29/01/2018 | FOR INFORMATION | KL | KA | LMGG | |
|-----|------------|---------------------|-------|---------|-------|---------|
| Rev | Rev. Date | Purpose of revision | Drawn | Checked | Rev'd | Apprv'd |

JACOBS
 65 Bothwell St, Glasgow, G2 7HX
 Tel: +44(0)141 243 8000 Fax: +44(0)141 226 3109
 www.jacobs.com

Client

 TRANSPORT SCOTLAND
 COMHALALBA

Project

 A9
 DUALLING
 PERTH TO INVERNESS
 Tay Crossing to Ballinluig

Drawing title
**TAY CROSSING TO BALLINLUIG
 PROPOSED MODIFICATIONS
 TO CULVERT ON
 WATERCOURSE WF20**

Drawing status
FOR INFORMATION

Scale
 NTS @ A1 DO NOT SCALE

Jacobs No. B2140003
 Drawing number **Figure A11.8.04** Rev 0

Reproduced by permission of Ordnance Survey on behalf of HMSO. © Crown copyright and database right 2017. All rights reserved. Ordnance Survey Licence number 100046668.

© Copyright 2015 Jacobs U.K. Limited. This concepts and information contained in this document are the property of Jacobs. Use or copying of this document in whole or in part without the written permission of Jacobs constitutes an infringement of copyright. Limitation: This drawing has been prepared on behalf of, and for the exclusive use of, Jacobs' Client, and is subject to, and issued in accordance with, the provisions of the contract between Jacobs and the Client. Jacobs accepts no liability or responsibility whatsoever for, or in respect of, any use of, or reliance upon, this drawing by any third party.

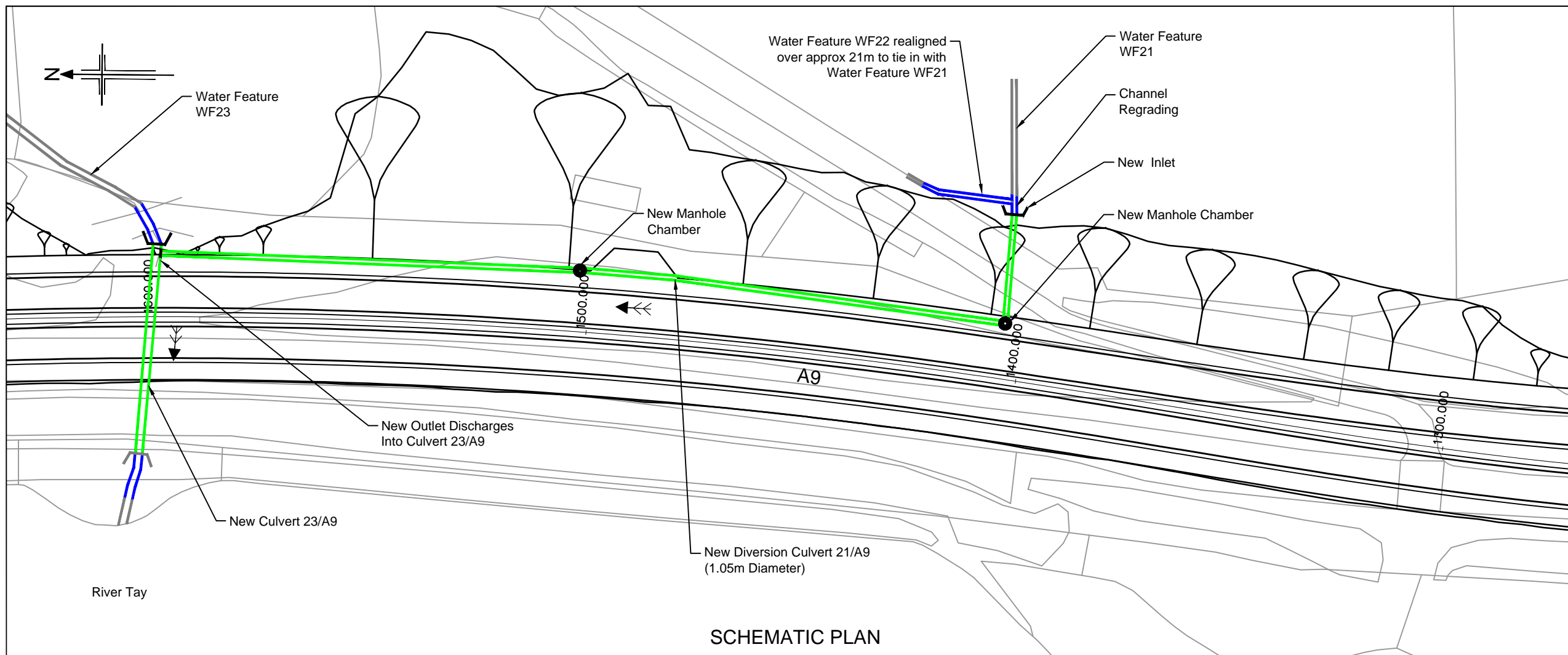

SCHMATIC PLAN

- Legend:
- New culvert/extension
 - - - Retained culvert
 - Realigned/regraded channel
 - Cascade
 - Inlet/outlet headwall (new)
 - Inlet/outlet headwall (retained)
 - Pre-earthworks drain and outfall
 - Access chamber
 - Flow direction
 - IL

- Notes:
1. All dimensions are in meters unless noted otherwise.
 2. All levels are in meters above ordnance datum.
 3. All details shown on this drawing are indicative only and subject to further development at specimen design stage. NOT FOR CONSTRUCTION.
 4. This drawing shall be read in conjunction with the 'Watercourse Crossing report' only and not in isolation.
 5. All 'new' and 'extended' culverts have been designed in accordance with the relevant provisions of DMRB.
 6. Where required 'scour protection measures' shall be provided within the zone of scour influence as indicated on the drawing. The nature and the extent of the scour protection measure will be further developed at specimen design stage in accordance with the relevant provisions of DMRB and relevant Good Practice Guides, taking into account flow hydraulics, channel geometry and channel morphology. This may include the provision of scour pools / stilling basin appropriately designed on a site by site basis.
 7. Where shown culverts shall be 'embedded' with natural river deposits to the depth shown.
 8. Where shown 'cascades' are required to safely convey the design flood event (0.5% AEP (200-year) plus allowance for climate change). The cascade geometry shown on the drawing is indicative only and will be subject to further development at specimen design stage. The nature of the cascade will take one of the following general forms:
 - Bedrock channel cascade.
 - Natural cascade with natural gravels, cobbles and rock forming individual steps.
 - Concrete cascade with stone pitching.
 The nature of the cascade will be determined at the specimen design stage taking into account hydraulic requirements, topography and nature of the underlying strata and its susceptibility to fluvial erosion.
 9. Where shown mammal ledges will be provided within the culvert in accordance with the relevant provisions of DMRB.

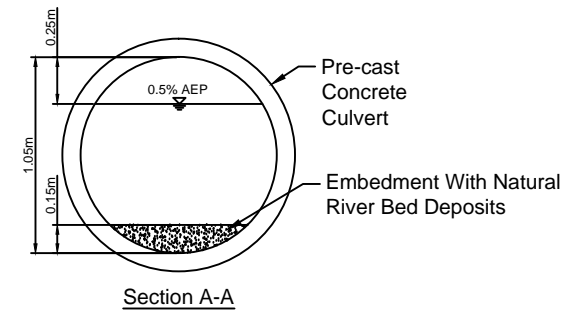

Section A-A

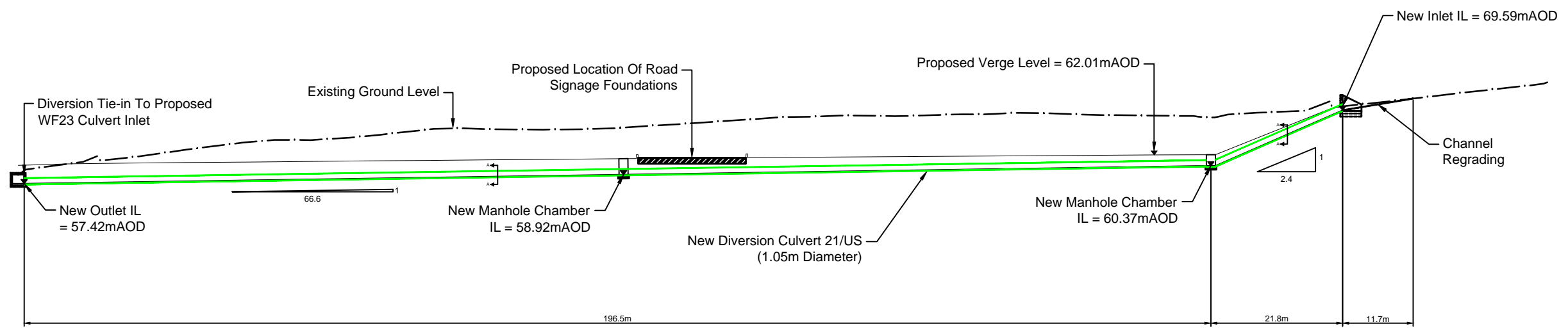

WATERCOURSE 21 LONGSECTION

| 0 | 29/01/2018 | FOR INFORMATION | KL | KA | LMGG | |
|-----|------------|---------------------|-------|---------|-------|---------|
| Rev | Rev. Date | Purpose of revision | Drawn | Checked | Rev'd | Apprv'd |



Drawing title
**TAY CROSSING TO BALLINLUIG
 PROPOSED MODIFICATIONS
 TO CULVERT ON
 WATERCOURSE WF21**

Drawing status
FOR INFORMATION

Scale
 NTS @ A1 DO NOT SCALE

Jacobs No.
 B2140003

Drawing number
Figure A11.8.05

Reproduced by permission of Ordnance Survey on behalf of HMSO. © Crown copyright and database right 2017. All rights reserved. Ordnance Survey Licence number 100046668.

© Copyright 2015 Jacobs U.K. Limited. The concepts and information contained in this document are the property of Jacobs. Use or copying of this document in whole or in part without the written permission of Jacobs constitutes an infringement of copyright. Limitation: This drawing has been prepared on behalf of, and for the exclusive use of, Jacobs' Client, and is subject to, and issued in accordance with, the provisions of the contract between Jacobs and the Client. Jacobs accepts no liability or responsibility whatsoever for, or in respect of, any use of, or reliance upon, this drawing by any third party.

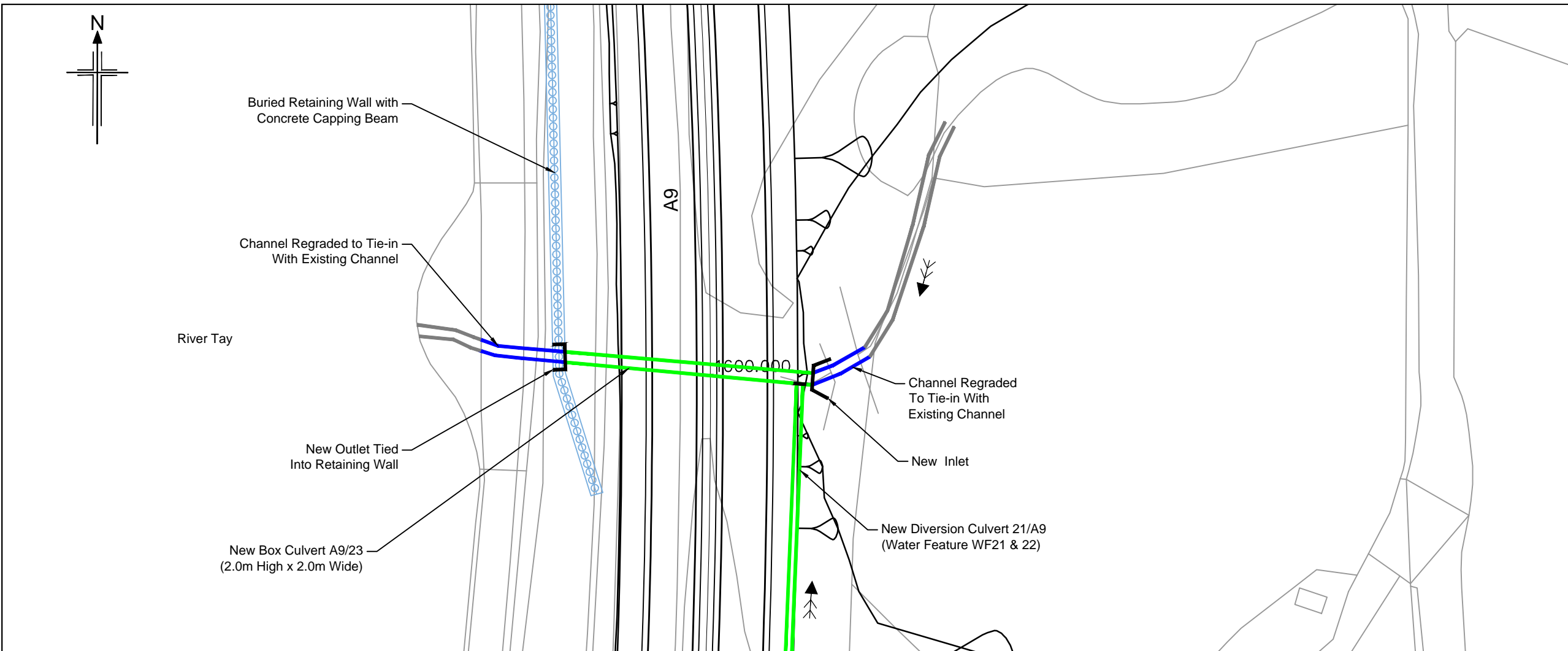

- Legend:**
- New culvert/extension
 - Retained culvert
 - Realigned/regraded channel
 - Cascade
 - Inlet/outlet headwall (new)
 - Inlet/outlet headwall (retained)
 - Pre-earthworks drain and outfall
 - Access chamber
 - Flow direction
 - Invert Level
- Notes:**
1. All dimensions are in meters unless noted otherwise.
 2. All levels are in meters above ordnance datum.
 3. All details shown on this drawing are indicative only and subject to further development at specimen design stage. NOT FOR CONSTRUCTION.
 4. This drawing shall be read in conjunction with the 'Watercourse Crossing report' only and not in isolation.
 5. All 'new' and 'extended' culverts have been designed in accordance with the relevant provisions of DMRB.
 6. Where required 'scour protection measures' shall be provided within the zone of scour influence as indicated on the drawing. The nature and the extent of the scour protection measure will be further developed at specimen design stage in accordance with the relevant provisions of DMRB and relevant Good Practice Guides, taking into account flow hydraulics, channel geometry and channel morphology. This may include the provision of scour pools / stilling basin appropriately designed on a site by site basis.
 7. Where shown culverts shall be 'embedded' with natural river deposits to the depth shown.
 8. Where shown 'cascades' are required to safely convey the design flood event (0.5% AEP (200-year) plus allowance for climate change). The cascade geometry shown on the drawing is indicative only and will be subject to further development at specimen design stage. The nature of the cascade will take one of the following general forms:
 - Bedrock channel cascade.
 - Natural cascade with natural gravels, cobbles and rock forming individual steps.
 - Concrete cascade with stone pitching.
 The nature of the cascade will be determined at the specimen design stage taking into account hydraulic requirements, topography and nature of the underlying strata and its susceptibility to fluvial erosion.
 9. Where shown mammal ledges will be provided within the culvert in accordance with the relevant provisions of DMRB.

SCHEMATIC PLAN

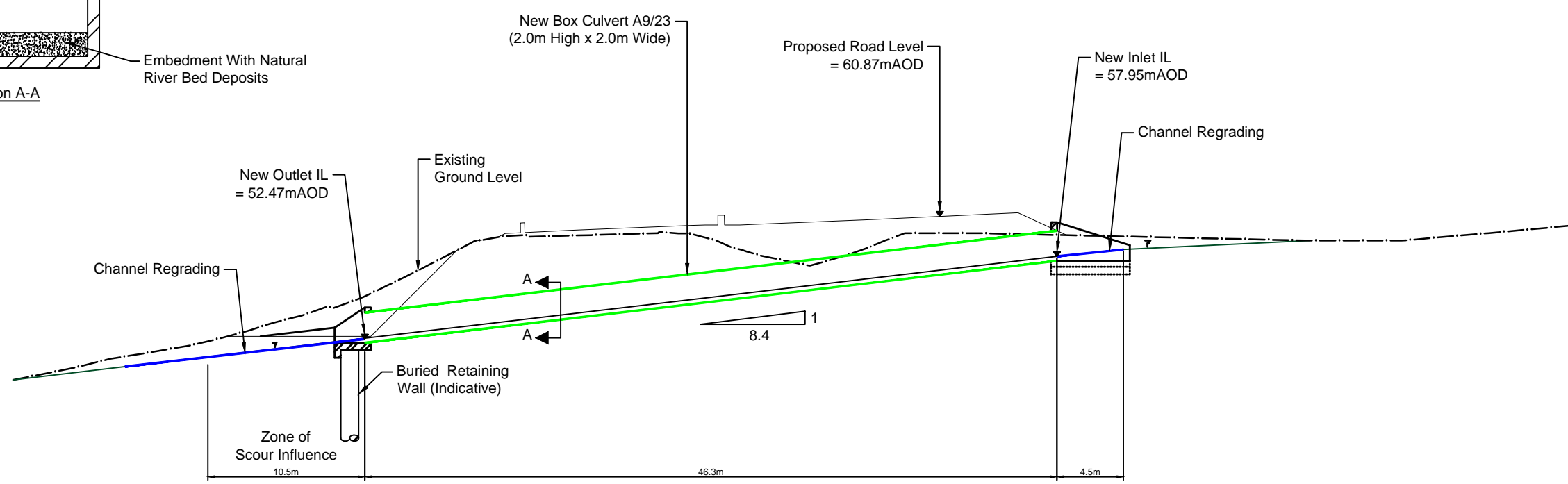
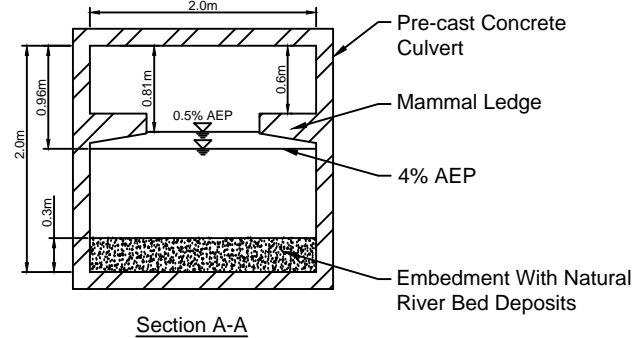

WATERCOURSE 23 LONGSECTION

Reproduced by permission of Ordnance Survey on behalf of HMSO. © Crown copyright and database right 2017. All rights reserved. Ordnance Survey Licence number 100046668.

| 0 | 29/05/2018 | FOR INFORMATION | KL | KA | LMGG | |
|-----|------------|---------------------|-------|---------|-------|---------|
| Rev | Rev. Date | Purpose of revision | Drawn | Checked | Rev'd | Apprv'd |

JACOBS
 85 Bothwell St, Glasgow, G2 7HX
 Tel: +44(0)141 243 8000 Fax: +44(0)141 226 3109
 www.jacobs.com

Client

 TRANSPORT SCOTLAND
 COMHALALBA

Project

 A9
 DUALLING
 PERTH TO INVERNESS
 Tay Crossing to Ballinluig

Drawing title
**TAY CROSSING TO BALLINLUIG
 PROPOSED MODIFICATIONS
 TO CULVERT ON
 WATERCOURSE WF23**

Drawing status
FOR INFORMATION

Scale
 NTS @ A1 DO NOT SCALE

Jacobs No. B2140003
 Drawing number
Figure A11.8.06 Rev 0

© Copyright 2015 Jacobs U.K. Limited. This concepts and information contained in this document are the property of Jacobs. Use or copying of this document in whole or in part without the written permission of Jacobs constitutes an infringement of copyright. Limitation: This drawing has been prepared on behalf of, and for the exclusive use of, the Client, and is subject to, and issued in accordance with, the provisions of the contract between Jacobs and the Client. Jacobs accepts no liability or responsibility whatsoever for, or in respect of, any use of, or reliance upon, this drawing by any third party.

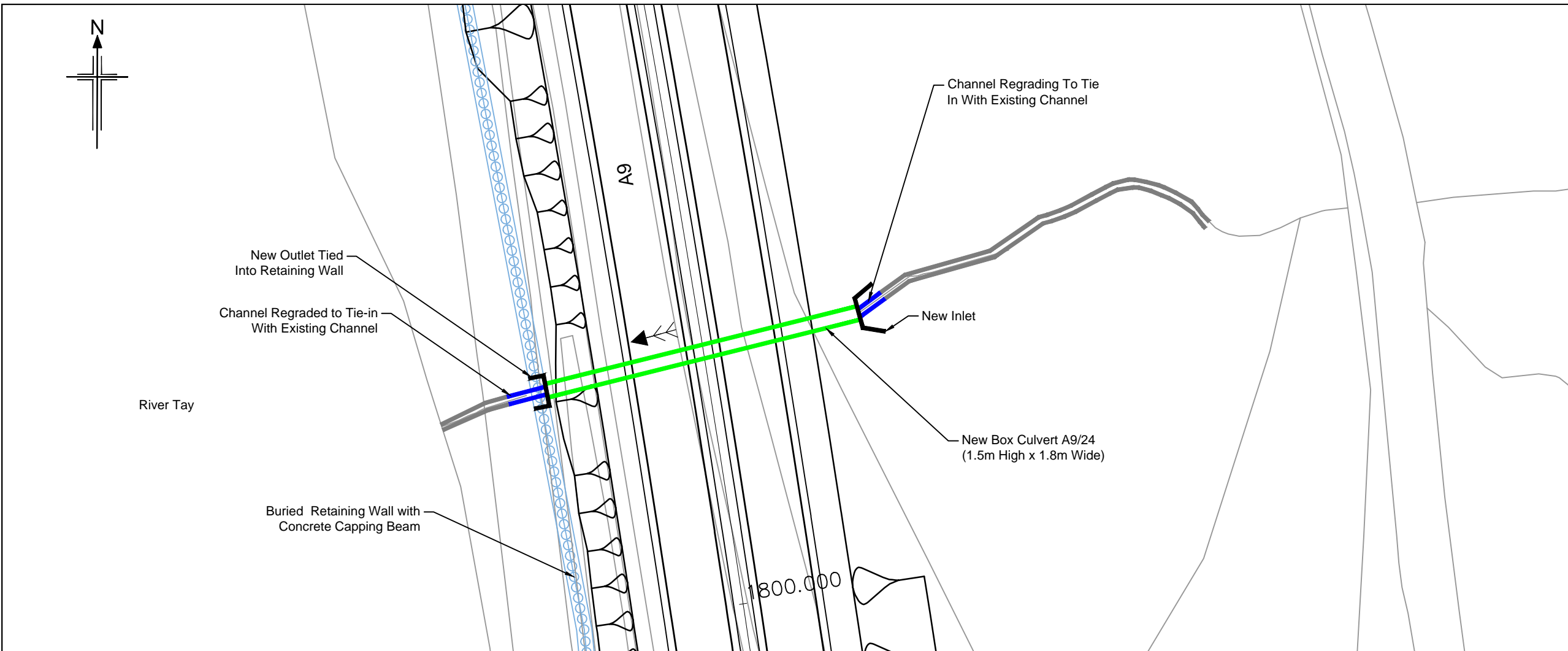

- Legend:
- New culvert/extension
 - - - Retained culvert
 - Realigned/regraded channel
 - Cascade
 - Inlet/outlet headwall (new)
 - Inlet/outlet headwall (retained)
 - Pre-earthworks drain and outfall
 - Access chamber
 - Flow direction
 - IL

- Notes:
1. All dimensions are in meters unless noted otherwise.
 2. All levels are in meters above ordnance datum.
 3. All details shown on this drawing are indicative only and subject to further development at specimen design stage. NOT FOR CONSTRUCTION.
 4. This drawing shall be read in conjunction with the 'Watercourse Crossing report' only and not in isolation.
 5. All 'new' and 'extended' culverts have been designed in accordance with the relevant provisions of DMRB.
 6. Where required 'scour protection measures' shall be provided within the zone of scour influence as indicated on the drawing. The nature and the extent of the scour protection measure will be further developed at specimen design stage in accordance with the relevant provisions of DMRB and relevant Good Practice Guides, taking into account flow hydraulics, channel geometry and channel morphology. This may include the provision of scour pools / stilling basin appropriately designed on a site by site basis.
 7. Where shown culverts shall be 'embedded' with natural river deposits to the depth shown.
 8. Where shown 'cascades' are required to safely convey the design flood event (0.5% AEP (200-year) plus allowance for climate change). The cascade geometry shown on the drawing is indicative only and will be subject to further development at specimen design stage. The nature of the cascade will take one of the following general forms:
 - Bedrock channel cascade.
 - Natural cascade with natural gravels, cobbles and rock forming individual steps.
 - Concrete cascade with stone pitching.
 The nature of the cascade will be determined at the specimen design stage taking into account hydraulic requirements, topography and nature of the underlying strata and its susceptibility to fluvial erosion.
 9. Where shown mammal ledges will be provided within the culvert in accordance with the relevant provisions of DMRB.

SCHEMATIC PLAN

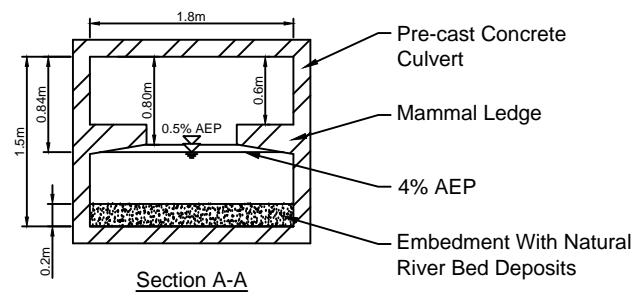

Section A-A

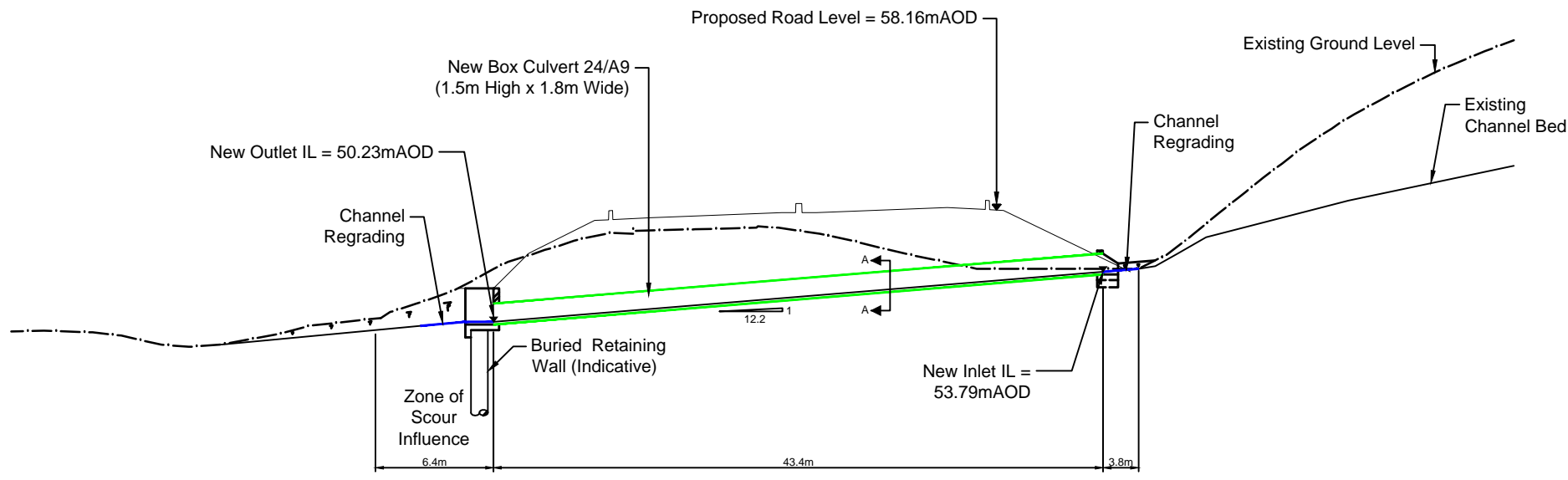

WATERCOURSE 24 LONGSECTION

| 0 | 29/05/2018 | FOR INFORMATION | KL | KA | LMCG | |
|-----|------------|---------------------|-------|---------|-------|---------|
| Rev | Rev. Date | Purpose of revision | Drawn | Checked | Rev'd | Apprv'd |

JACOBS
 85 Bothwell St, Glasgow, G2 7HX
 Tel: +44(0)141 243 8000 Fax: +44(0)141 226 3109
 www.jacobs.com

Client

Project

Drawing title

**TAY CROSSING TO BALLINLUIG
 PROPOSED MODIFICATIONS
 TO CULVERT ON
 WATERCOURSE WF24**

Drawing status: FOR INFORMATION

| | | |
|----------------|-----------------|--------------|
| Scale | NTS @ A1 | DO NOT SCALE |
| Jacobs No. | B2140003 | |
| Drawing number | Figure A11.8.07 | Rev 0 |

Reproduced by permission of Ordnance Survey on behalf of HMSO. © Crown copyright and database right 2017. All rights reserved. Ordnance Survey Licence number 100046668.

© Copyright 2015 Jacobs U.K. Limited. This concepts and information contained in this document are the property of Jacobs. Use or copying of this document in whole or in part without the written permission of Jacobs constitutes an infringement of copyright. Limitation: This drawing has been prepared on behalf of, and for the exclusive use of Jacobs' Client, and is subject to, and issued in accordance with, the provisions of the contract between Jacobs and the Client. Jacobs accepts no liability or responsibility whatsoever for, or in respect of, any use of, or reliance upon, this drawing by any third party.

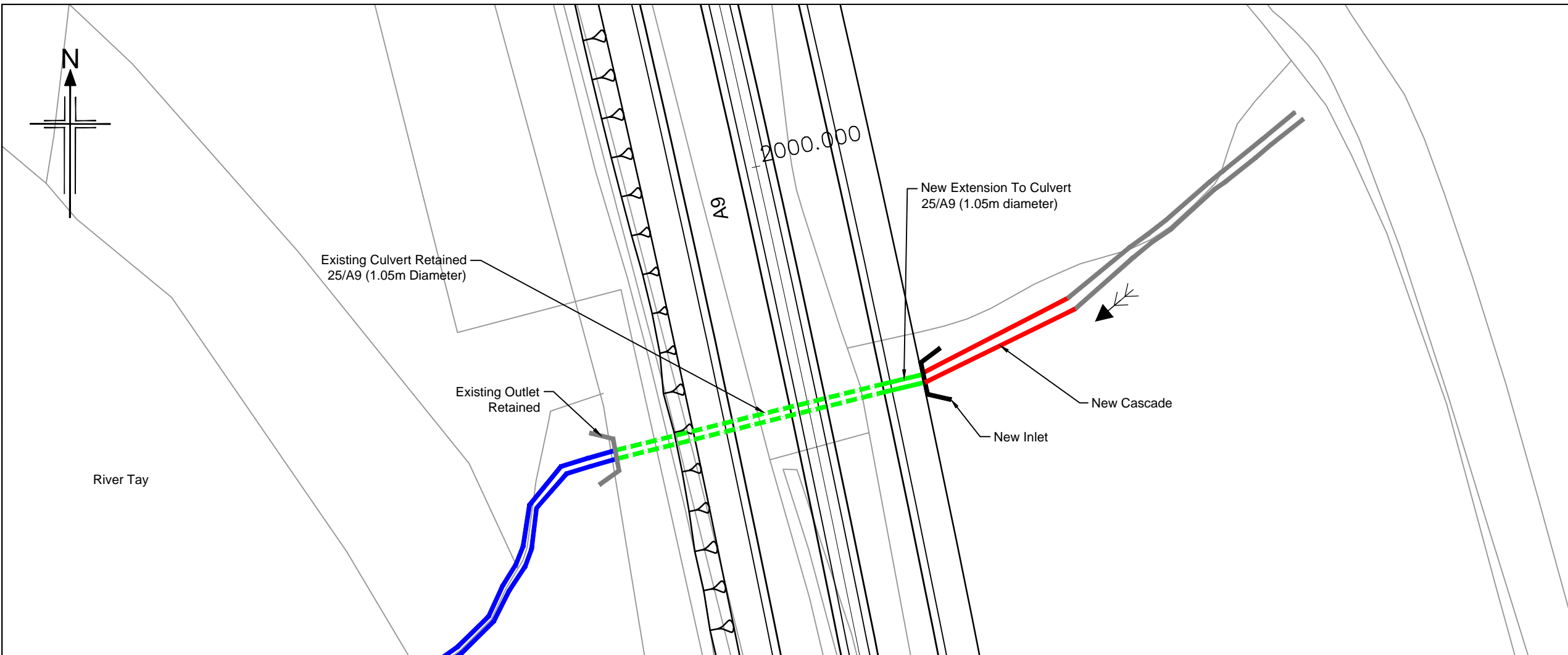

SCHMATIC PLAN

- Legend:
- New culvert/extension
 - - - Retained culvert
 - Realigned/reggraded channel
 - Cascade
 - Inlet/outlet headwall (new)
 - Inlet/outlet headwall (retained)
 - Pre-earthworks drain and outfall
 - Access chamber
 - Flow direction
 - IL

- Notes:
1. All dimensions are in meters unless noted otherwise.
 2. All levels are in meters above ordnance datum.
 3. All details shown on this drawing are indicative only and subject to further development at specimen design stage. NOT FOR CONSTRUCTION.
 4. This drawing shall be read in conjunction with the 'Watercourse Crossing report' only and not in isolation.
 5. All 'new' and 'extended' culverts have been designed in accordance with the relevant provisions of DMRB.
 6. Where required 'scour protection measures' shall be provided within the zone of scour influence as indicated on the drawing. The nature and the extent of the scour protection measure will be further developed at specimen design stage in accordance with the relevant provisions of DMRB and relevant Good Practice Guides, taking into account flow hydraulics, channel geometry and channel morphology. This may include the provision of scour pools / stilling basin appropriately designed on a site by site basis.
 7. Where shown culverts shall be 'embedded' with natural river deposits to the depth shown.
 8. Where shown 'cascades' are required to safely convey the design flood event (0.5% AEP (200-year) plus allowance for climate change). The cascade geometry shown on the drawing is indicative only and will be subject to further development at specimen design stage. The nature of the cascade will take one of the following general forms:
 - Bedrock channel cascade.
 - Natural cascade with natural gravels, cobbles and rock forming individual steps.
 - Concrete cascade with stone pitching.
 The nature of the cascade will be determined at the specimen design stage taking into account hydraulic requirements, topography and nature of the underlying strata and its susceptibility to fluvial erosion.
 9. Where shown mammal ledges will be provided within the culvert in accordance with the relevant provisions of DMRB.

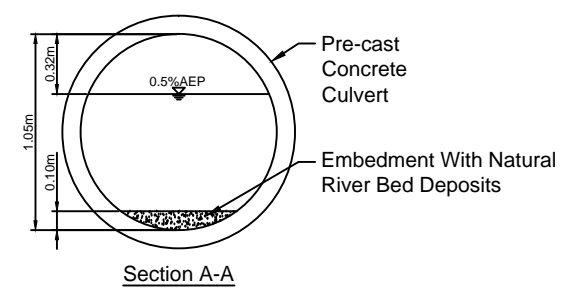

Section A-A

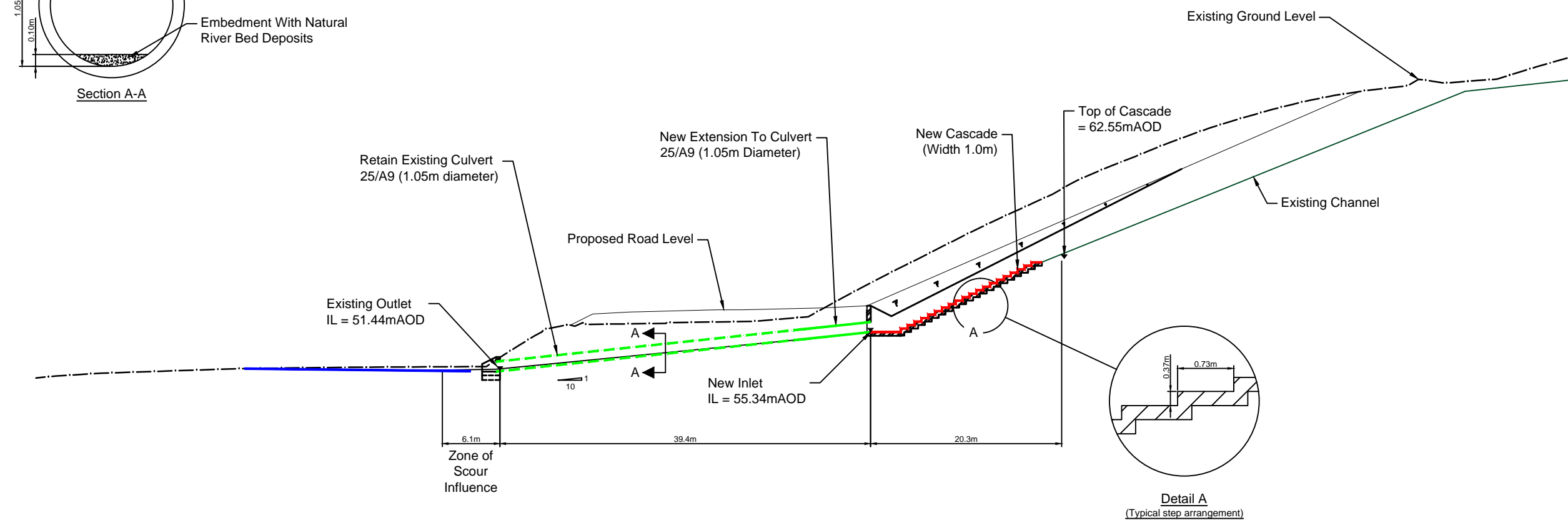

WATERCOURSE 25 LONGSECTION

| Rev | Rev. Data | Purpose of revision | Drawn | Checked | Rev'd | Apprv'd |
|-----|------------|---------------------|-------|---------|-------|---------|
| 0 | 29/01/2018 | FOR INFORMATION | KL | KA | LMGG | |

JACOBS
 85 Bothwell St, Glasgow, G2 7HX
 Tel: +44(0)141 243 8000 Fax: +44(0)141 226 3109
 www.jacobs.com



Drawing title
**TAY CROSSING TO BALLINLUIG
 PROPOSED MODIFICATIONS
 TO CULVERT ON
 WATERCOURSE WF25**

Drawing status: FOR INFORMATION

| | | |
|----------------|-----------------|--------------|
| Scale | NTS @ A1 | DO NOT SCALE |
| Jacobs No. | B2140003 | |
| Drawing number | Figure A11.8.08 | Rev 0 |

Reproduced by permission of Ordnance Survey on behalf of HMSO. © Crown copyright and database right 2017. All rights reserved. Ordnance Survey Licence number 100046668.

© Copyright 2015 Jacobs U.K. Limited. This concepts and information contained in this document are the property of Jacobs. Use or copying of this document in whole or in part without the written permission of Jacobs constitutes an infringement of copyright. Limitation: This drawing has been prepared on behalf of, and for the exclusive use of, the Client. Jacobs accepts no liability or responsibility whatsoever for, or in respect of, any use of, or reliance upon, this drawing by any third party.

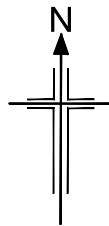

Existing Culvert 28/A9 Retained
(1.05m Diameter)

Existing Inlet

Existing Outlet

River Tay

SCHEMATIC PLAN

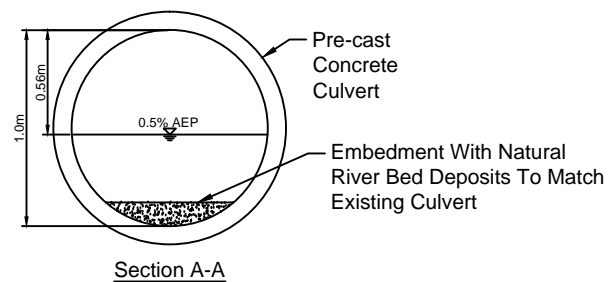

Existing Outlet IL = 51.49mAOD

Existing Culvert 28/A9 Retained
(1.0m Diameter)

Existing Inlet IL = 54.88mAOD

Proposed Road Level = 58.38mAOD

Existing Ground Level

Zone of Scour Influence

60m

WATERCOURSE 28 LONGSECTION

- Legend:
- New culvert/extension
 - - - Retained culvert
 - Realigned/regraded channel
 - Cascade
 - Inlet/outlet headwall (new)
 - Inlet/outlet headwall (retained)
 - Pre-earthworks drain and outfall
 - Access chamber
 - Flow direction
 - Invert Level

- Notes:
1. All dimensions are in meters unless noted otherwise.
 2. All levels are in meters above ordnance datum.
 3. All details shown on this drawing are indicative only and subject to further development at specimen design stage. NOT FOR CONSTRUCTION.
 4. This drawing shall be read in conjunction with the 'Watercourse Crossing report' only and not in isolation.
 5. All 'new' and 'extended' culverts have been designed in accordance with the relevant provisions of DMRB.
 6. Where required 'scour protection measures' shall be provided within the zone of scour influence as indicated on the drawing. The nature and the extent of the scour protection measure will be further developed at specimen design stage in accordance with the relevant provisions of DMRB and relevant Good Practice Guides, taking into account flow hydraulics, channel geometry and channel morphology. This may include the provision of scour pools / stilling basin appropriately designed on a site by site basis.
 7. Where shown culverts shall be 'embedded' with natural river deposits to the depth shown.
 8. Where shown 'cascades' are required to safely convey the design flood event (0.5% AEP (200-year) plus allowance for climate change). The cascade geometry shown on the drawing is indicative only and will be subject to further development at specimen design stage. The nature of the cascade will take one of the following general forms:
 - Bedrock channel cascade.
 - Natural cascade with natural gravels, cobbles and rock forming individual steps.
 - Concrete cascade with stone pitching.
 The nature of the cascade will be determined at the specimen design stage taking into account hydraulic requirements, topography and nature of the underlying strata and its susceptibility to fluvial erosion.
 9. Where shown mammal ledges will be provided within the culvert in accordance with the relevant provisions of DMRB.

| Rev | Rev. Date | Purpose of revision | Drawn | Checked | Rev'd | Apprv'd |
|-----|------------|---------------------|-------|---------|-------|---------|
| 0 | 29/01/2018 | FOR INFORMATION | KL | KA | LMCG | |

JACOBS
85 Bothwell St, Glasgow, G2 7HX
Tel: +44(0)141 243 8000 Fax: +44(0)141 226 3109
www.jacobs.com



Drawing title
**TAY CROSSING TO BALLINLUIG
PROPOSED MODIFICATIONS
TO CULVERT ON
WATERCOURSE WF28**

Drawing status: FOR INFORMATION

| | | |
|----------------|-----------------|--------------|
| Scale | NTS @ A1 | DO NOT SCALE |
| Jacobs No. | B2140003 | |
| Drawing number | Figure A11.8.09 | Rev 0 |

Reproduced by permission of Ordnance Survey on behalf of HMSO. © Crown copyright and database right 2017. All rights reserved. Ordnance Survey Licence number 100046668.

© Copyright 2015 Jacobs U.K. Limited. The concepts and information contained in this document are the property of Jacobs. Use or copying of this document in whole or in part without the written permission of Jacobs constitutes an infringement of copyright. Limitation: This drawing has been prepared on behalf of, and for the exclusive use of, Jacobs' Client, and is issued in accordance with the provisions of the contract between Jacobs and the Client. Jacobs accepts no liability or responsibility whatsoever for, or in respect of, any use of, or reliance upon, this drawing by any third party.

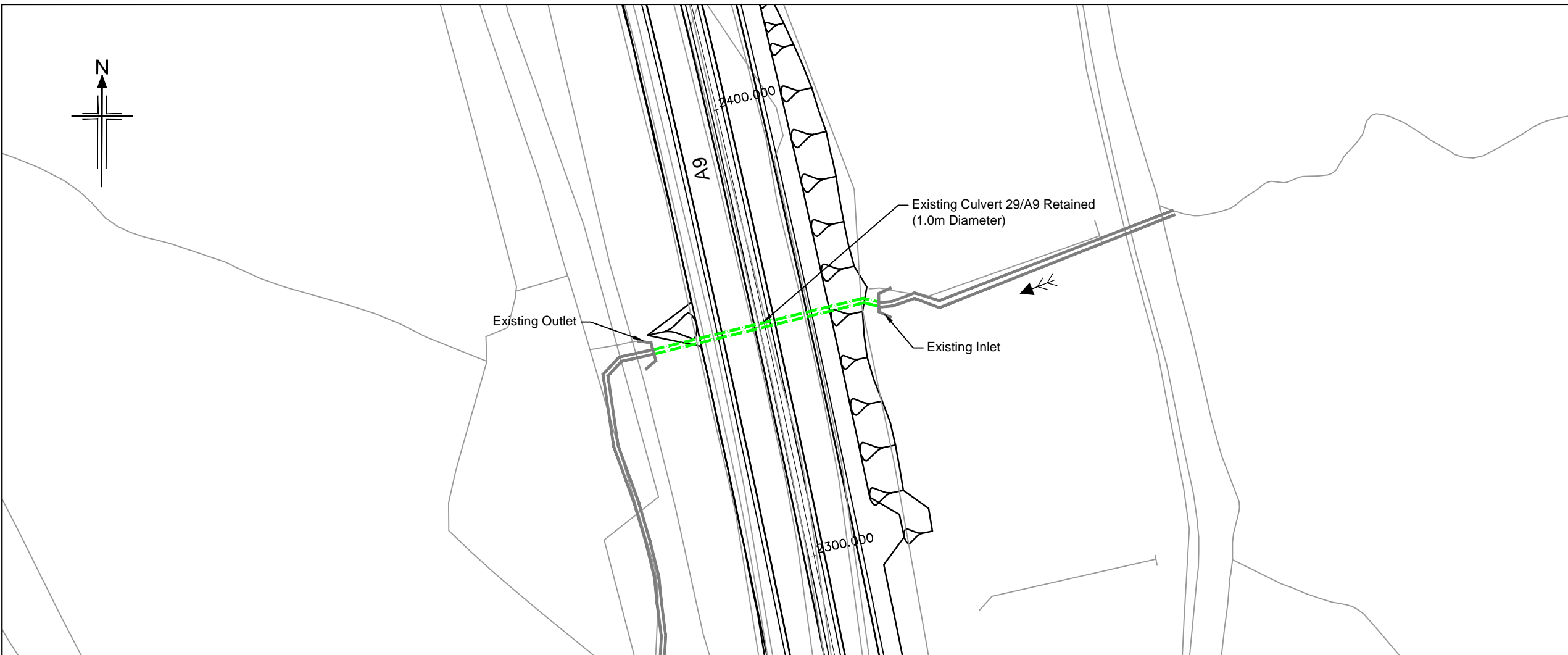

- Legend:
- New culvert/extension
 - - - Retained culvert
 - Realigned/regraded channel
 - Cascade
 - Inlet/outlet headwall (new)
 - Inlet/outlet headwall (retained)
 - Pre-earthworks drain and outfall
 - Access chamber
 - Flow direction
 - Invert Level

- Notes:
1. All dimensions are in meters unless noted otherwise.
 2. All levels are in meters above ordnance datum.
 3. All details shown on this drawing are indicative only and subject to further development at specimen design stage. NOT FOR CONSTRUCTION.
 4. This drawing shall be read in conjunction with the 'Watercourse Crossing report' only and not in isolation.
 5. All 'new' and 'extended' culverts have been designed in accordance with the relevant provisions of DMRB.
 6. Where required 'scour protection measures' shall be provided within the zone of scour influence as indicated on the drawing. The nature and the extent of the scour protection measure will be further developed at specimen design stage in accordance with the relevant provisions of DMRB and relevant Good Practice Guides, taking into account flow hydraulics, channel geometry and channel morphology. This may include the provision of scour pools / stilling basin appropriately designed on a site by site basis.
 7. Where shown culverts shall be 'embedded' with natural river deposits to the depth shown.
 8. Where shown 'cascades' are required to safely convey the design flood event (0.5% AEP (200-year) plus allowance for climate change). The cascade geometry shown on the drawing is indicative only and will be subject to further development at specimen design stage. The nature of the cascade will take one of the following general forms:
 - Bedrock channel cascade.
 - Natural cascade with natural gravels, cobbles and rock forming individual steps.
 - Concrete cascade with stone pitching.
 The nature of the cascade will be determined at the specimen design stage taking into account hydraulic requirements, topography and nature of the underlying strata and its susceptibility to fluvial erosion.
 9. Where shown mammal ledges will be provided within the culvert in accordance with the relevant provisions of DMRB.

SCHEMATIC PLAN

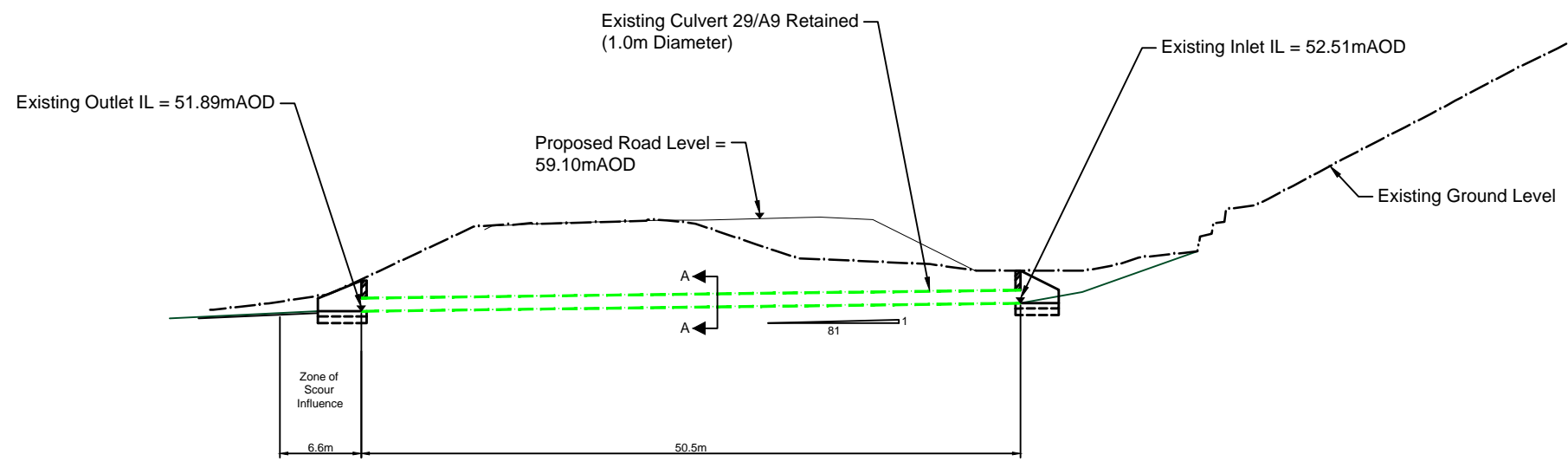
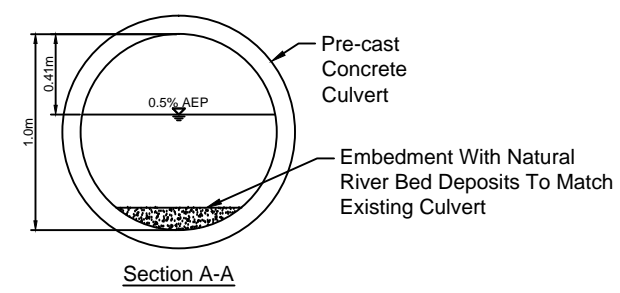

WATERCOURSE 29 LONGSECTION

| 0 | 29/01/2018 | FOR INFORMATION | KL | KA | LMGG | |
|-----|------------|---------------------|-------|---------|-------|---------|
| Rev | Rev. Date | Purpose of revision | Drawn | Checked | Rev'd | Apprv'd |

JACOBS
 85 Bothwell St, Glasgow, G2 7HX
 Tel: +44(0)141 243 8000 Fax: +44(0)141 226 3109
 www.jacobs.com



Drawing title
**TAY CROSSING TO BALLINLUIG
 PROPOSED MODIFICATIONS
 TO CULVERT ON
 WATERCOURSE WF29**

Drawing status
FOR INFORMATION

Scale **NTS @ A1** **DO NOT SCALE**
 Jacobs No. **B2140003**

Drawing number **Figure A11.8.10** Rev **0**

Reproduced by permission of Ordnance Survey on behalf of HMSO. © Crown copyright and database right 2017. All rights reserved. Ordnance Survey Licence number 100046668.

© Copyright 2015 Jacobs U.K. Limited. The concepts and information contained in this document are the property of Jacobs. Use or copying of this document in whole or in part without the written permission of Jacobs constitutes an infringement of copyright. Limitation: This drawing has been prepared on behalf of, and for the exclusive use of, Jacobs' Client, and is issued in accordance with the provisions of the contract between Jacobs and the Client. Jacobs accepts no liability or responsibility whatsoever for, or in respect of, any use of, or reliance upon, this drawing by any third party.

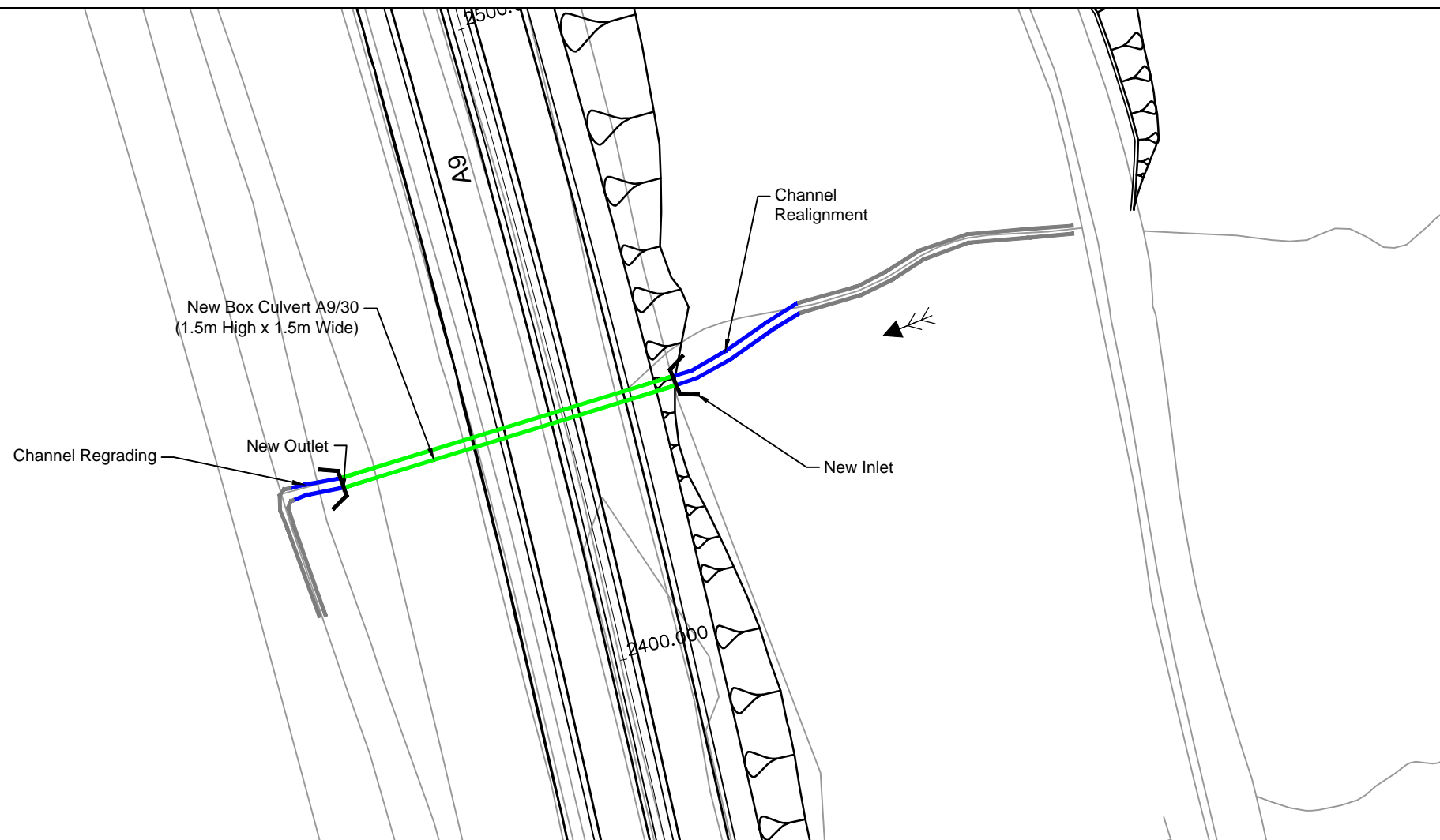
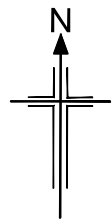

- Legend:
- New culvert/extension
 - - - Retained culvert
 - Realigned/regraded channel
 - Cascade
 -
 -
 -
 -
 -
 -

- Notes:
1. All dimensions are in meters unless noted otherwise.
 2. All levels are in meters above ordnance datum.
 3. All details shown on this drawing are indicative only and subject to further development at specimen design stage. NOT FOR CONSTRUCTION.
 4. This drawing shall be read in conjunction with the 'Watercourse Crossing report' only and not in isolation.
 5. All 'new' and 'extended' culverts have been designed in accordance with the relevant provisions of DMRB.
 6. Where required 'scour protection measures' shall be provided within the zone of scour influence as indicated on the drawing. The nature and the extent of the scour protection measure will be further developed at specimen design stage in accordance with the relevant provisions of DMRB and relevant Good Practice Guides, taking into account flow hydraulics, channel geometry and channel morphology. This may include the provision of scour pools / stilling basin appropriately designed on a site by site basis.
 7. Where shown culverts shall be 'embedded' with natural river deposits to the depth shown.
 8. Where shown 'cascades' are required to safely convey the design flood event (0.5% AEP (200-year) plus allowance for climate change). The cascade geometry shown on the drawing is indicative only and will be subject to further development at specimen design stage. The nature of the cascade will take one of the following general forms:
 - Bedrock channel cascade.
 - Natural cascade with natural gravels, cobbles and rock forming individual steps.
 - Concrete cascade with stone pitching.
 The nature of the cascade will be determined at the specimen design stage taking into account hydraulic requirements, topography and nature of the underlying strata and its susceptibility to fluvial erosion.
 9. Where shown mammal ledges will be provided within the culvert in accordance with the relevant provisions of DMRB.

SCHEMATIC PLAN

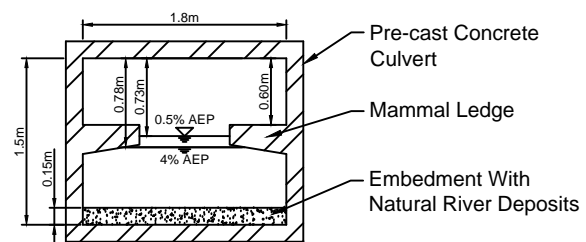

Section A-A

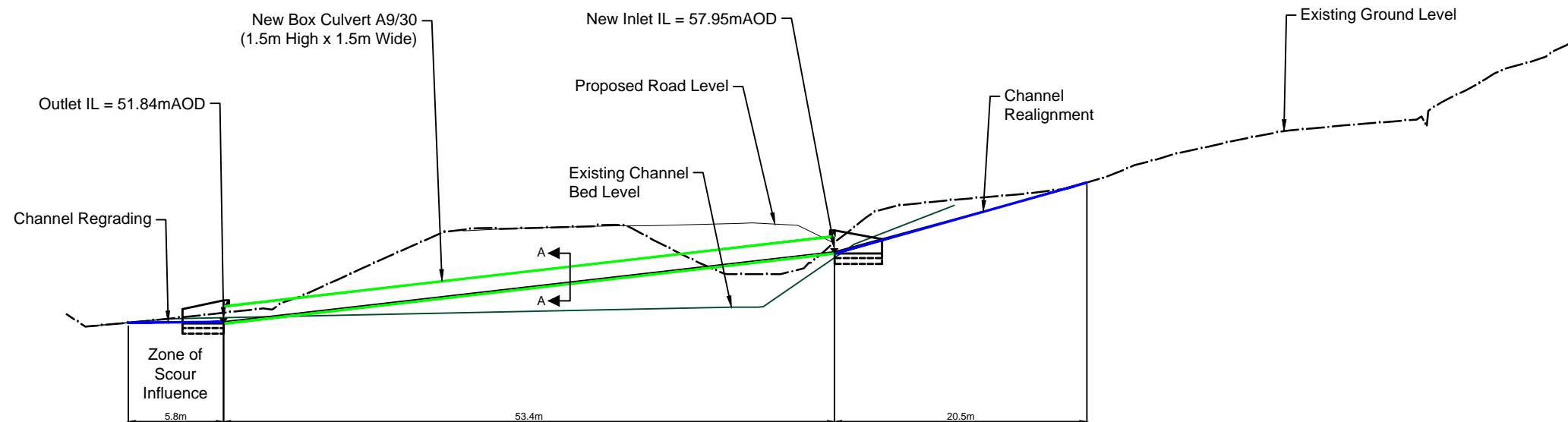

WATERCOURSE 30 LONGSECTION

| 0 | 29/01/2018 | FOR INFORMATION | KL | KA | LMGG | |
|-----|------------|---------------------|-------|---------|-------|--------|
| Rev | Rev. Date | Purpose of revision | Drawn | Checked | Rev'd | Appr'd |



Drawing title
**TAY CROSSING TO BALLINLUIG
 PROPOSED MODIFICATIONS
 TO CULVERT ON
 WATERCOURSE WF30**

Drawing status
FOR INFORMATION

Scale
 NTS @ A1 DO NOT SCALE

Jacobs No. B2140003
 Drawing number
Figure A11.8.11 Rev 0

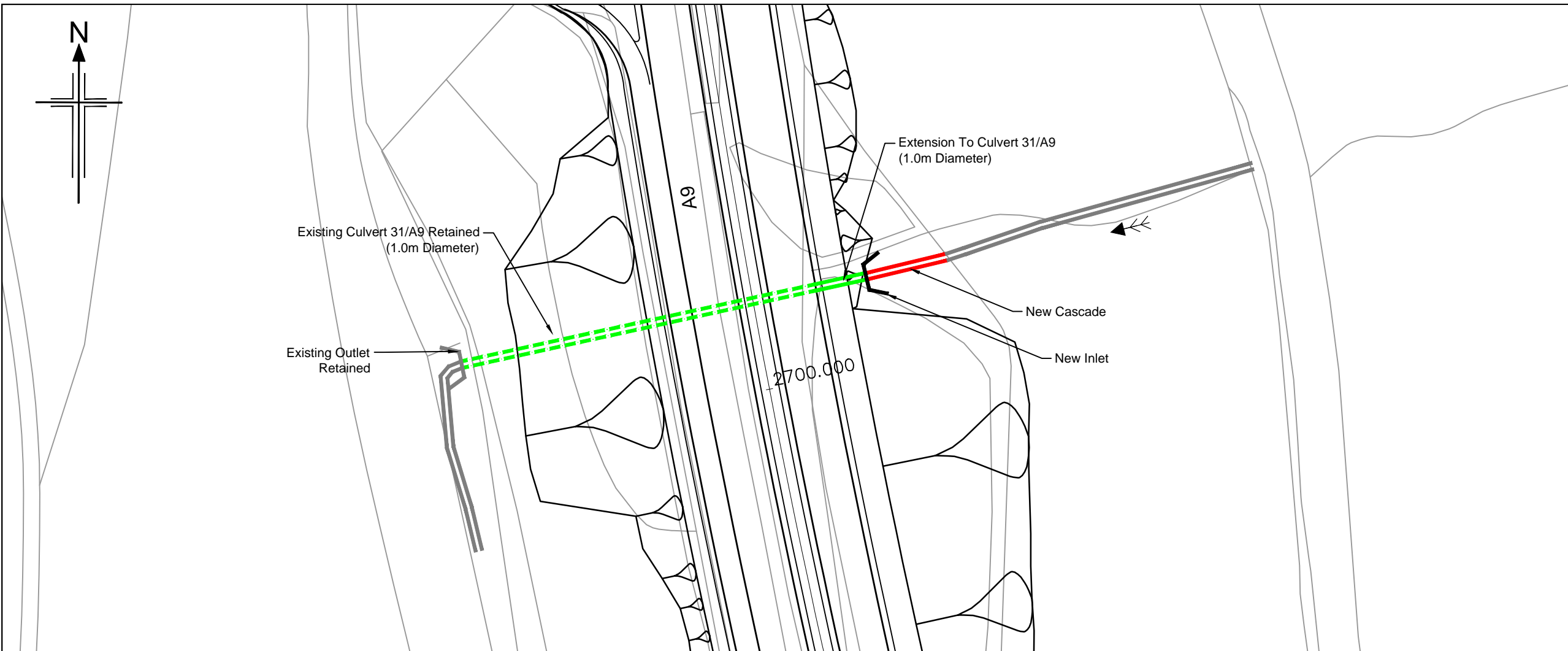

- Legend:
- New culvert/extension
 - - - Retained culvert
 - Realigned/regraded channel
 - Cascade
 -
 -
 -
 -
 -
 -

- Notes:
1. All dimensions are in meters unless noted otherwise.
 2. All levels are in meters above ordnance datum.
 3. All details shown on this drawing are indicative only and subject to further development at specimen design stage. NOT FOR CONSTRUCTION.
 4. This drawing shall be read in conjunction with the 'Watercourse Crossing report' only and not in isolation.
 5. All 'new' and 'extended' culverts have been designed in accordance with the relevant provisions of DMRB.
 6. Where required 'scour protection measures' shall be provided within the zone of scour influence as indicated on the drawing. The nature and the extent of the scour protection measure will be further developed at specimen design stage in accordance with the relevant provisions of DMRB and relevant Good Practice Guides, taking into account flow hydraulics, channel geometry and channel morphology. This may include the provision of scour pools / stilling basin appropriately designed on a site by site basis.
 7. Where shown culverts shall be 'embedded' with natural river deposits to the depth shown.
 8. Where shown 'cascades' are required to safely convey the design flood event (0.5% AEP (200-year) plus allowance for climate change). The cascade geometry shown on the drawing is indicative only and will be subject to further development at specimen design stage. The nature of the cascade will take one of the following general forms:
 - Bedrock channel cascade.
 - Natural cascade with natural gravels, cobbles and rock forming individual steps.
 - Concrete cascade with stone pitching.
 The nature of the cascade will be determined at the specimen design stage taking into account hydraulic requirements, topography and nature of the underlying strata and its susceptibility to fluvial erosion.
 9. Where shown mammal ledges will be provided within the culvert in accordance with the relevant provisions of DMRB.

SCHEMATIC PLAN

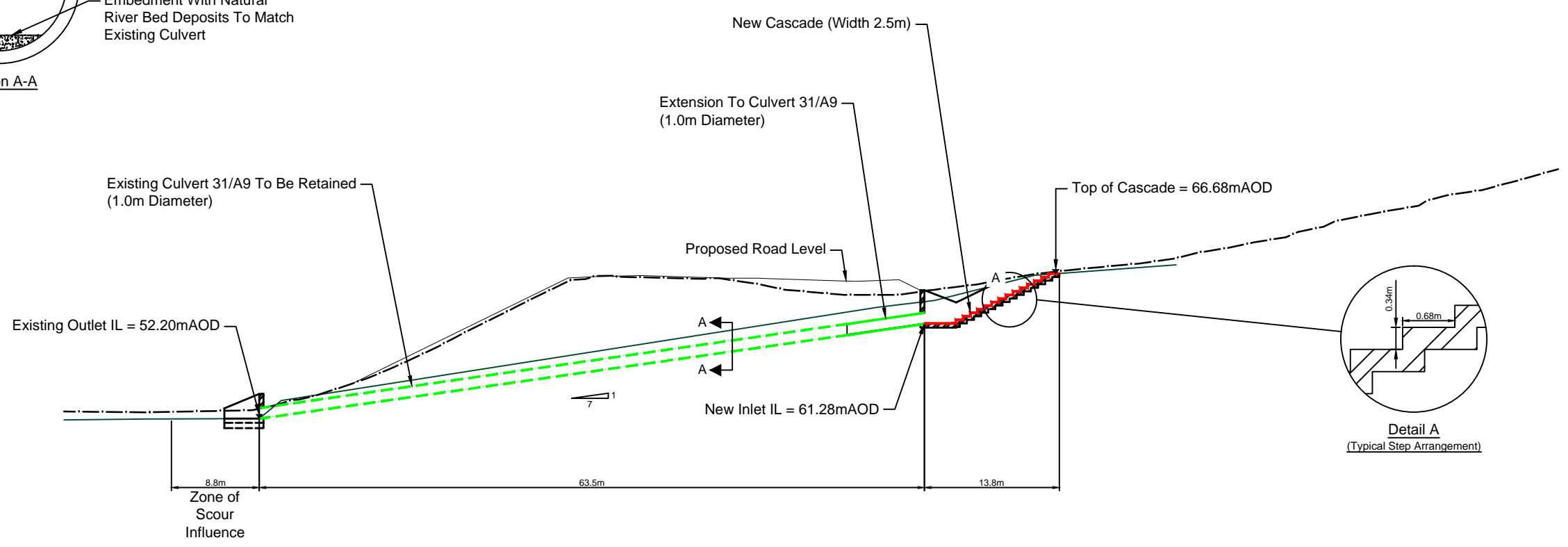
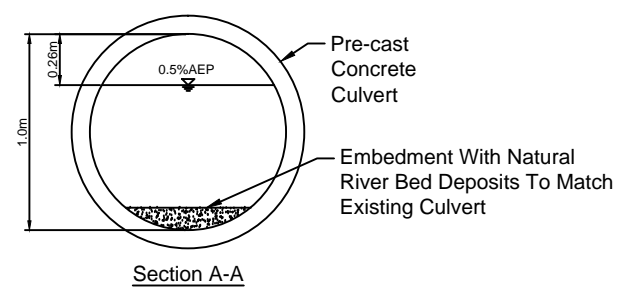

WATERCOURSE 31 LONGSECTION

| 0 | 29/01/2018 | FOR INFORMATION | KL | KA | LMGG | |
|-----|------------|---------------------|-------|---------|-------|-------|
| Rev | Rev. Date | Purpose of revision | Drawn | Checked | Rev'd | App'd |



Drawing title
TAY CROSSING TO BALLINLUIG PROPOSED MODIFICATIONS TO CULVERT ON WATERCOURSE WF31

Drawing status
FOR INFORMATION

Scale
 NTS @ A1 **DO NOT SCALE**

Jacobs No.
 B2140003

Drawing number
Figure A11.8.12

Rev
 0

Reproduced by permission of Ordnance Survey on behalf of HMSO. © Crown copyright and database right 2017. All rights reserved. Ordnance Survey Licence number 100046668.

© Copyright 2015 Jacobs U.K. Limited. The concepts and information contained in this document are the property of Jacobs. Use or copying of this document in whole or in part without the written permission of Jacobs constitutes an infringement of copyright. Limitation: This drawing has been prepared on behalf of, and for the exclusive use of, Jacobs' Client, and is subject to, and issued in accordance with, the provisions of the contract between Jacobs and the Client. Jacobs accepts no liability or responsibility whatsoever for, or in respect of, any use of, or reliance upon, this drawing by any third party.

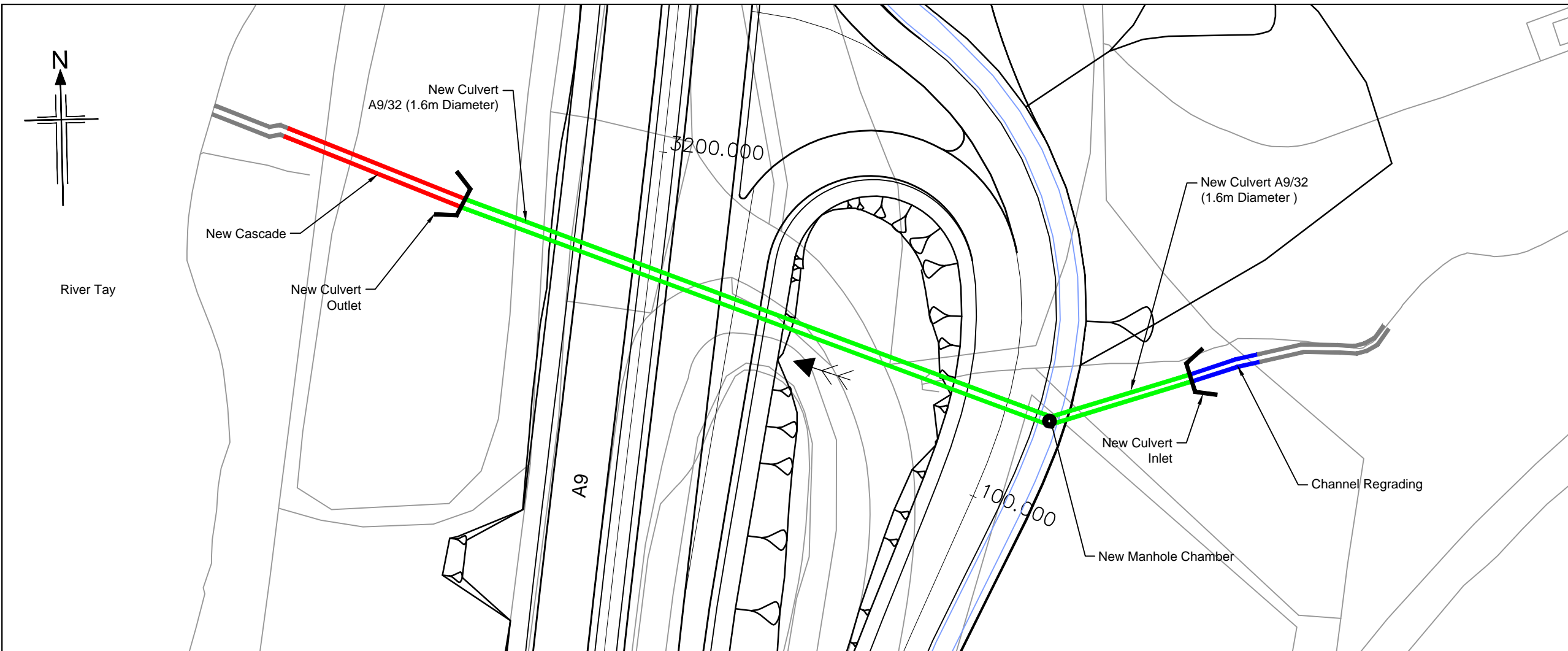

- Legend:**
- New culvert/extension
 - - - Retained culvert
 - Realigned/regraded channel
 - Cascade
 - Inlet/outlet headwall (new)
 - Inlet/outlet headwall (retained)
 - Pre-earthworks drain and outfall
 - Access chamber
 - Flow direction
 - IL

- Notes:**
1. All dimensions are in meters unless noted otherwise.
 2. All levels are in meters above ordnance datum.
 3. All details shown on this drawing are indicative only and subject to further development at specimen design stage. NOT FOR CONSTRUCTION.
 4. This drawing shall be read in conjunction with the 'Watercourse Crossing report' only and not in isolation.
 5. All 'new' and 'extended' culverts have been designed in accordance with the relevant provisions of DMRB.
 6. Where required 'scour protection measures' shall be provided within the zone of scour influence as indicated on the drawing. The nature and the extent of the scour protection measure will be further developed at specimen design stage in accordance with the relevant provisions of DMRB and relevant Good Practice Guides, taking into account flow hydraulics, channel geometry and channel morphology. This may include the provision of scour pools / stilling basin appropriately designed on a site by site basis.
 7. Where shown culverts shall be 'embedded' with natural river deposits to the depth shown.
 8. Where shown 'cascades' are required to safely convey the design flood event (0.5% AEP (200-year) plus allowance for climate change). The cascade geometry shown on the drawing is indicative only and will be subject to further development at specimen design stage. The nature of the cascade will take one of the following general forms:
 - Bedrock channel cascade.
 - Natural cascade with natural gravels, cobbles and rock forming individual steps.
 - Concrete cascade with stone pitching.
 The nature of the cascade will be determined at the specimen design stage taking into account hydraulic requirements, topography and nature of the underlying strata and its susceptibility to fluvial erosion.
 9. Where shown mammal ledges will be provided within the culvert in accordance with the relevant provisions of DMRB.

SCHEMATIC PLAN

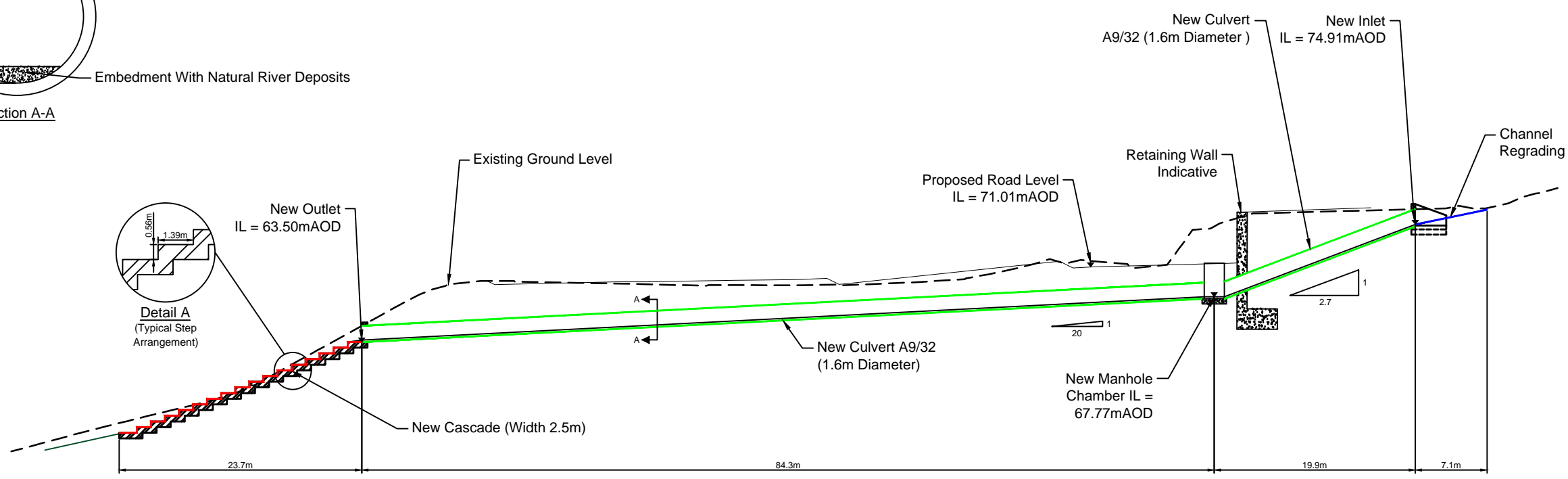
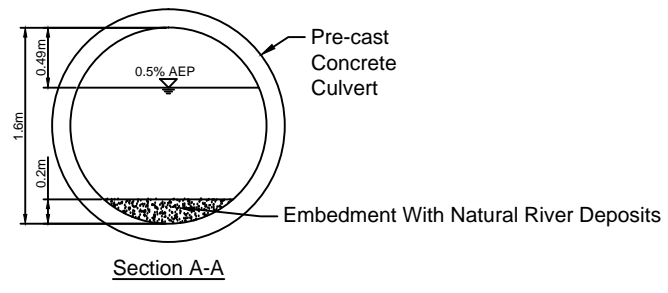

WATERCOURSE 32 LONGSECTION

| 0 | 29/01/2018 | FOR INFORMATION | KL | KA | LMGG | |
|-----|------------|---------------------|-------|---------|-------|---------|
| Rev | Rev. Date | Purpose of revision | Drawn | Checked | Rev'd | Apprv'd |



Drawing title
**TAY CROSSING TO BALLINLUIG
 PROPOSED MODIFICATIONS
 TO CULVERT ON
 WATERCOURSE WF32**

| | | |
|-----------------------------------|-----------------|--------------|
| Drawing status FOR INFORMATION | | |
| Scale | NTS @ A1 | DO NOT SCALE |
| Jacobs No. | B2140003 | |
| Drawing number | Figure A11.8.13 | Rev 0 |

Reproduced by permission of Ordnance Survey on behalf of HMSO. © Crown copyright and database right 2017. All rights reserved. Ordnance Survey Licence number 100046668.

© Copyright 2015 Jacobs U.K. Limited. The concepts and information contained in this document are the property of Jacobs. Use or copying of this document in whole or in part without the written permission of Jacobs constitutes an infringement of copyright. Limitation: This drawing has been prepared on behalf of, and for the exclusive use of, Jacobs' Client, and is subject to, and issued in accordance with, the provisions of the contract between Jacobs and the Client. Jacobs accepts no liability or responsibility whatsoever for, or in respect of, any use of, or reliance upon, this drawing by any third party.

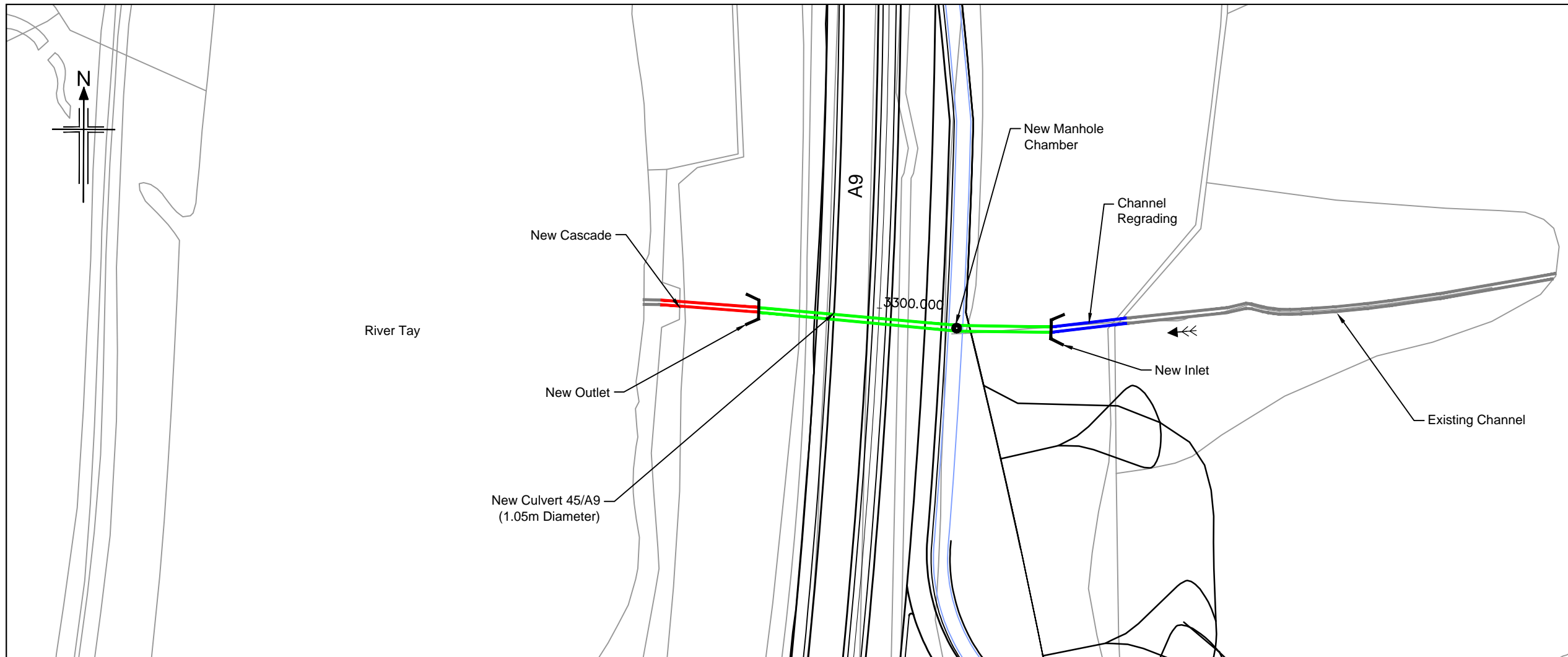

- Legend:
- New culvert/extension
 - - - Retained culvert
 - Realigned/regraded channel
 - Cascade
 - Inlet/outlet headwall (new)
 - Inlet/outlet headwall (retained)
 - Pre-earthworks drain and outfall
 - Access chamber
 - Flow direction
 - IL

- Notes:
1. All dimensions are in meters unless noted otherwise.
 2. All levels are in meters above ordnance datum.
 3. All details shown on this drawing are indicative only and subject to further development at specimen design stage. NOT FOR CONSTRUCTION.
 4. This drawing shall be read in conjunction with the 'Watercourse Crossing report' only and not in isolation.
 5. All 'new' and 'extended' culverts have been designed in accordance with the relevant provisions of DMRB.
 6. Where required 'scour protection measures' shall be provided within the zone of scour influence as indicated on the drawing. The nature and the extent of the scour protection measure will be further developed at specimen design stage in accordance with the relevant provisions of DMRB and relevant Good Practice Guides, taking into account flow hydraulics, channel geometry and channel morphology. This may include the provision of scour pools / stilling basin appropriately designed on a site by site basis.
 7. Where shown culverts shall be 'embedded' with natural river deposits to the depth shown.
 8. Where shown 'cascades' are required to safely convey the design flood event (0.5% AEP (200-year) plus allowance for climate change). The cascade geometry shown on the drawing is indicative only and will be subject to further development at specimen design stage. The nature of the cascade will take one of the following general forms:
 - Bedrock channel cascade.
 - Natural cascade with natural gravels, cobbles and rock forming individual steps.
 - Concrete cascade with stone pitching.
 The nature of the cascade will be determined at the specimen design stage taking into account hydraulic requirements, topography and nature of the underlying strata and its susceptibility to fluvial erosion.
 9. Where shown mammal ledges will be provided within the culvert in accordance with the relevant provisions of DMRB.

SCHEMATIC PLAN

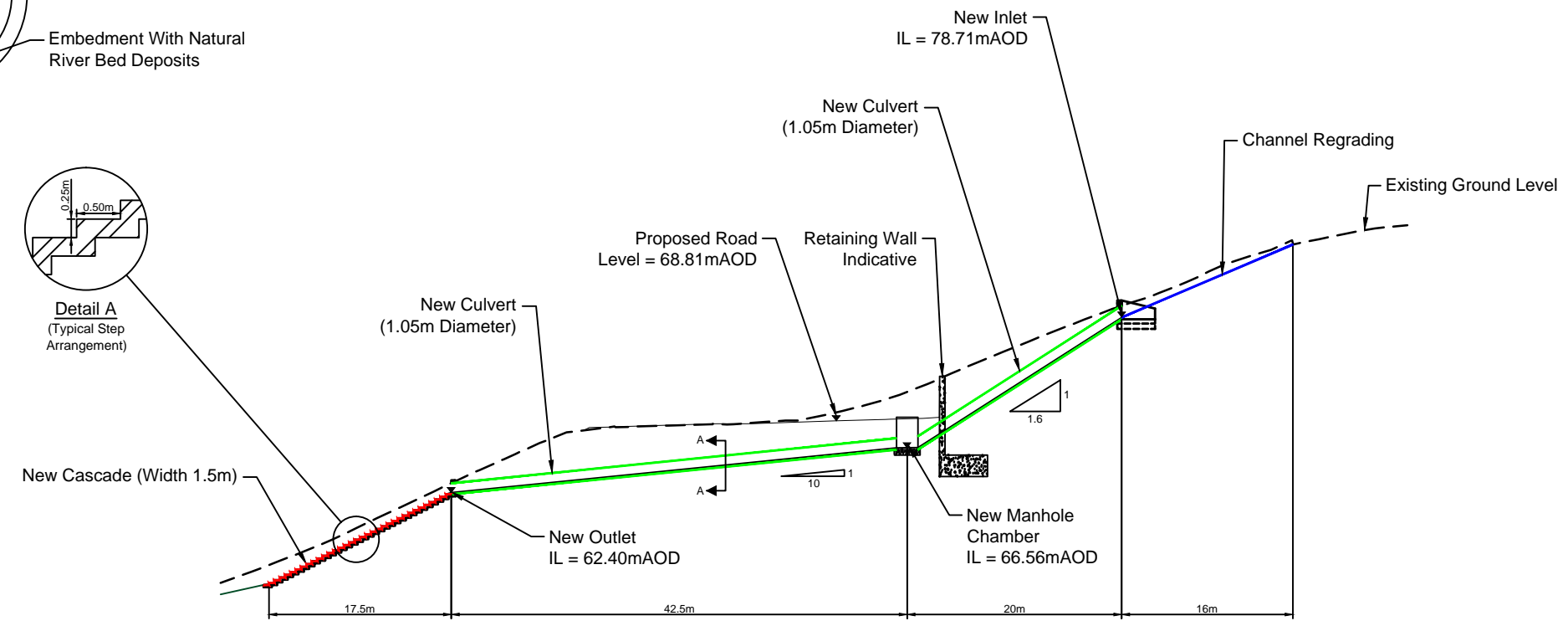
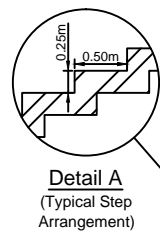
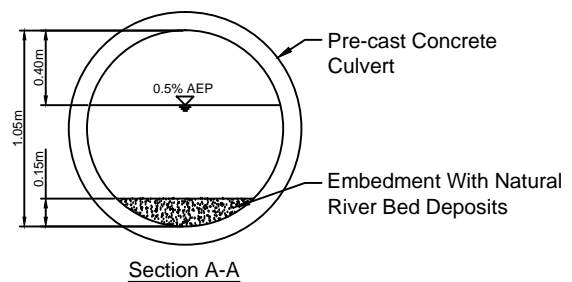

WATERCOURSE 33 LONGSECTION

| 0 | 29/01/2018 | FOR INFORMATION | KL | KA | LMGG | |
|-----|------------|---------------------|-------|---------|-------|---------|
| Rev | Rev. Date | Purpose of revision | Drawn | Checked | Rev'd | Apprv'd |



Drawing title
**TAY CROSSING TO BALLINLUIG
 PROPOSED MODIFICATIONS
 TO CULVERT ON
 WATERCOURSE WF33**

Drawing status
FOR INFORMATION

Scale
 NTS @ A1 DO NOT SCALE

Jacobs No. B2140003

Drawing number
Figure A11.8.14 Rev
 0

Reproduced by permission of Ordnance Survey on behalf of HMSO. © Crown copyright and database right 2017. All rights reserved. Ordnance Survey Licence number 100046668.

© Copyright 2015 Jacobs U.K. Limited. The concepts and information contained in this document are the property of Jacobs. Use or copying of this document in whole or in part without the written permission of Jacobs constitutes an infringement of copyright. Limitation: This drawing has been prepared on behalf of, and for the exclusive use of, Jacobs' Client, and is subject to, and issued in accordance with, the provisions of the contract between Jacobs and the Client. Jacobs accepts no liability or responsibility whatsoever for, or in respect of, any use of, or reliance upon, this drawing by any third party.

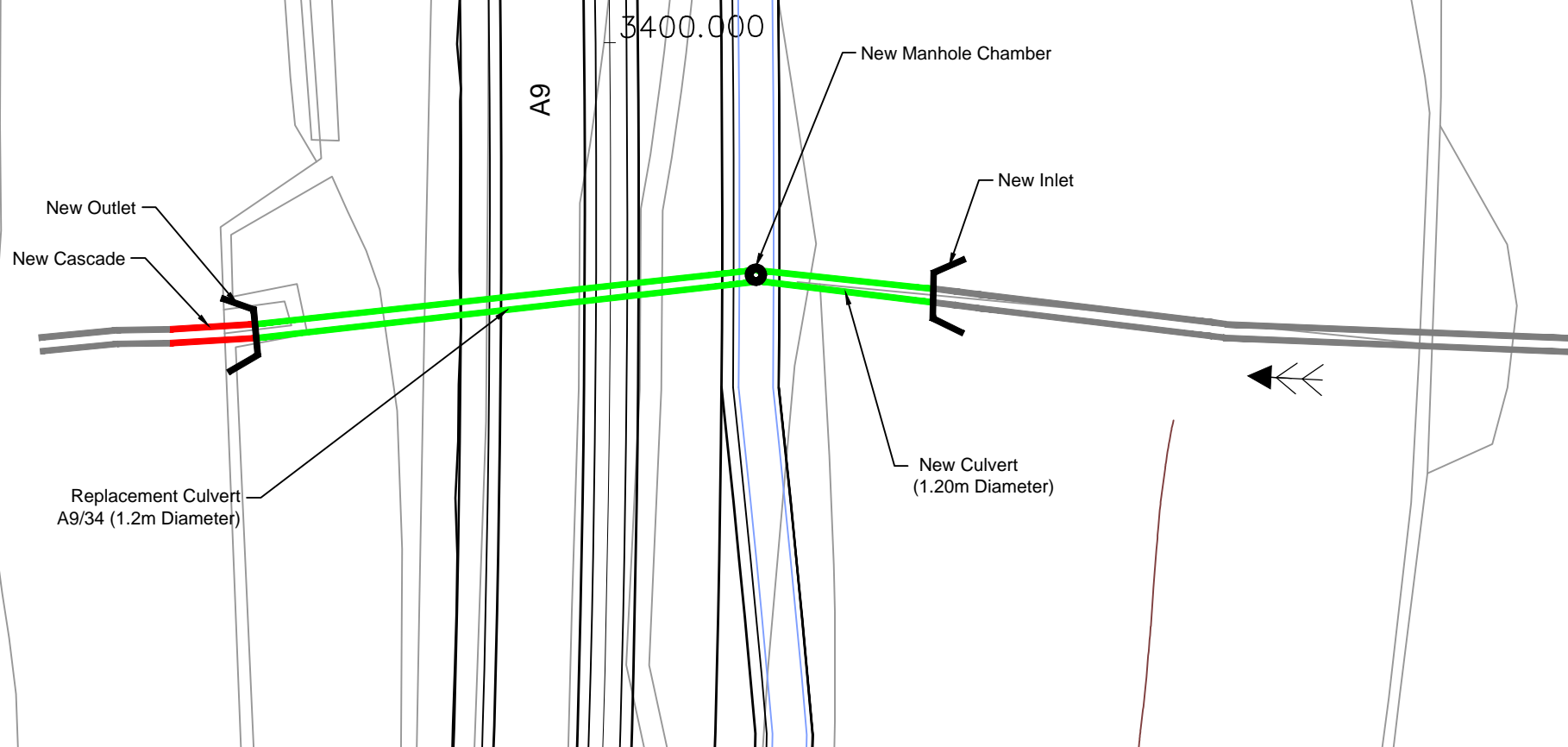
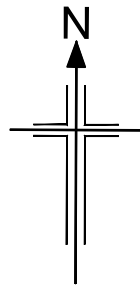

SCHMATIC PLAN

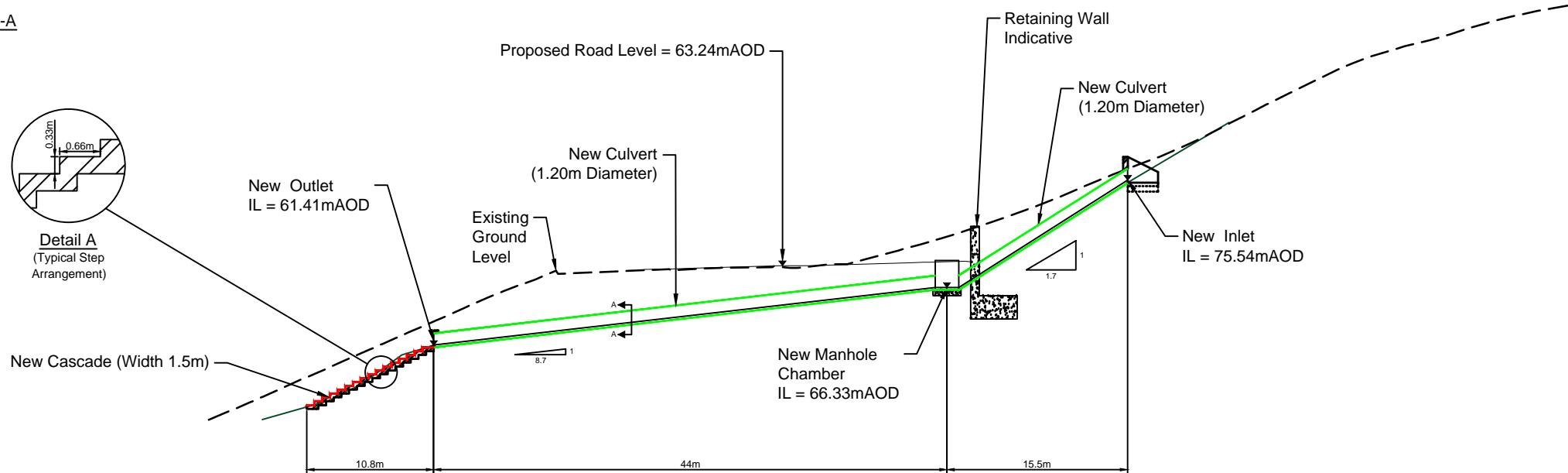
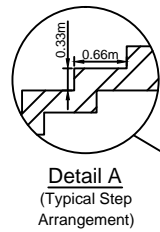
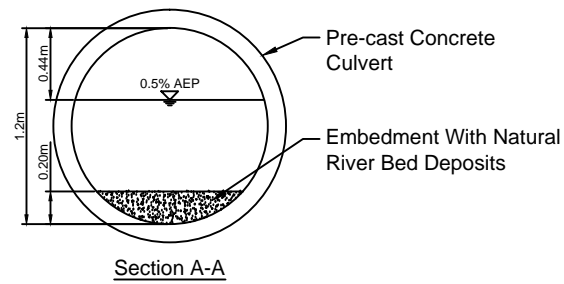

WATERCOURSE 34 LONGSECTION

Legend:

| | |
|--|----------------------------------|
| | New culvert/extension |
| | Retained culvert |
| | Realigned/reggraded channel |
| | Cascade |
| | Inlet/outlet headwall (new) |
| | Inlet/outlet headwall (retained) |
| | Pre-earthworks drain and outfall |
| | Access chamber |
| | Flow direction |
| | Invert Level |

- Notes:
- All dimensions are in meters unless noted otherwise.
 - All levels are in meters above ordnance datum.
 - All details shown on this drawing are indicative only and subject to further development at specimen design stage. NOT FOR CONSTRUCTION.
 - This drawing shall be read in conjunction with the 'Watercourse Crossing report' only and not in isolation.
 - All 'new' and 'extended' culverts have been designed in accordance with the relevant provisions of DMRB.
 - Where required 'scour protection measures' shall be provided within the zone of scour influence as indicated on the drawing. The nature and the extent of the scour protection measure will be further developed at specimen design stage in accordance with the relevant provisions of DMRB and relevant Good Practice Guides, taking into account flow hydraulics, channel geometry and channel morphology. This may include the provision of scour pools / stilling basin appropriately designed on a site by site basis.
 - Where shown culverts shall be 'embedded' with natural river deposits to the depth shown.
 - Where shown 'cascades' are required to safely convey the design flood event (0.5% AEP (200-year) plus allowance for climate change). The cascade geometry shown on the drawing is indicative only and will be subject to further development at specimen design stage. The nature of the cascade will take one of the following general forms:
 - Bedrock channel cascade.
 - Natural cascade with natural gravels, cobbles and rock forming individual steps.
 - Concrete cascade with stone pitching.
 The nature of the cascade will be determined at the specimen design stage taking into account hydraulic requirements, topography and nature of the underlying strata and its susceptibility to fluvial erosion.
 - Where shown mammal ledges will be provided within the culvert in accordance with the relevant provisions of DMRB.

| 0 | 29/01/2018 | FOR INFORMATION | KL | KA | LMCG | |
|-----|------------|---------------------|-------|---------|-------|---------|
| Rev | Rev. Date | Purpose of revision | Drawn | Checked | Rev'd | Apprv'd |



Drawing title
**TAY CROSSING TO BALLINLUIG
 PROPOSED MODIFICATIONS
 TO CULVERT ON
 WATERCOURSE WF34**

Drawing status
FOR INFORMATION

Scale
 NTS @ A1
DO NOT SCALE

Jacobs No.
 B2140003

Drawing number
Figure A11.8.15

Rev
 0

Reproduced by permission of Ordnance Survey on behalf of HMSO. © Crown copyright and database right 2017. All rights reserved. Ordnance Survey Licence number 100046668.

© Copyright 2015 Jacobs U.K. Limited. The concepts and information contained in this document are the property of Jacobs. Use or copying of this document in whole or in part without the written permission of Jacobs constitutes an infringement of copyright. Limitation: This drawing has been prepared on behalf of, and for the exclusive use of, Jacobs' Client, and is subject to, and issued in accordance with, the provisions of the contract between Jacobs and the Client. Jacobs accepts no liability or responsibility whatsoever for, or in respect of, any use of, or reliance upon, this drawing by any third party.

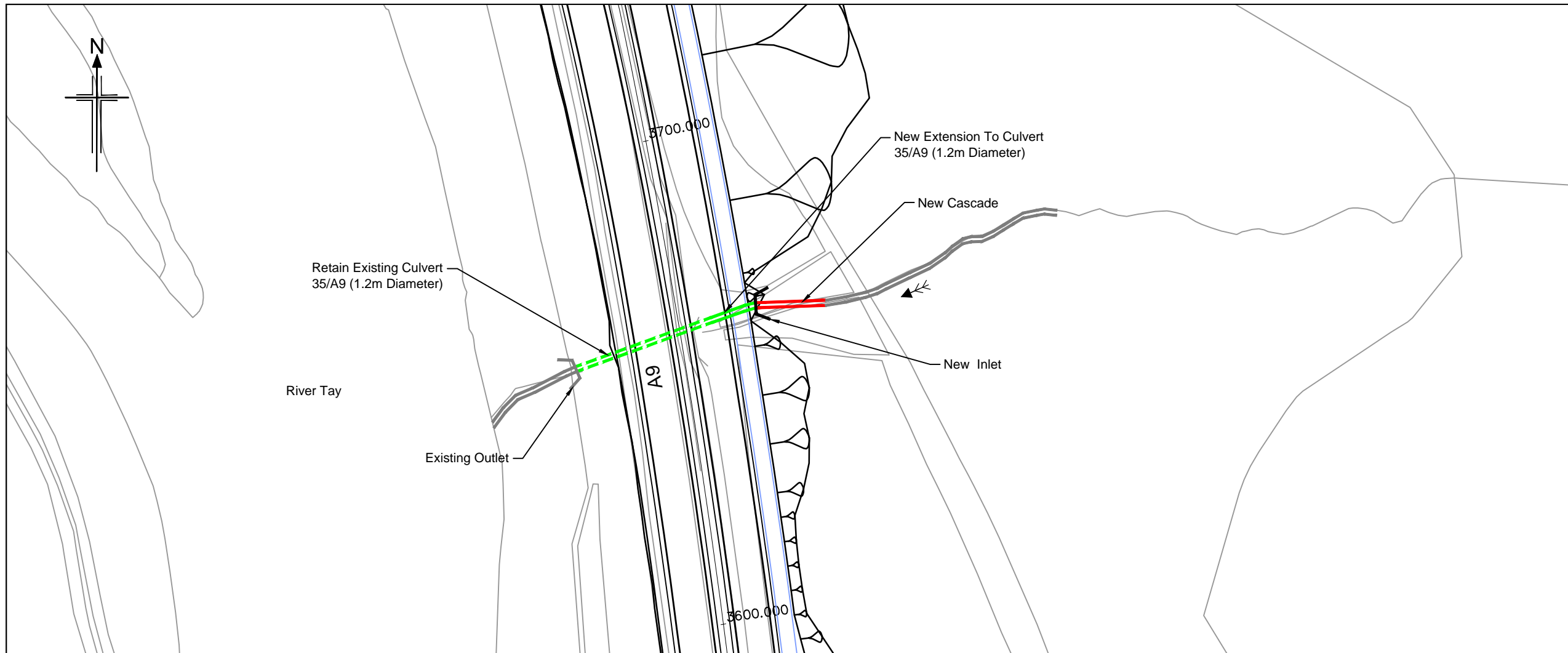

- Legend:
- New culvert/extension
 - - - Retained culvert
 - Realigned/regraded channel
 - Cascade
 - Inlet/outlet headwall (new)
 - Inlet/outlet headwall (retained)
 - Pre-earthworks drain and outfall
 - Access chamber
 - Flow direction
 - IL

- Notes:
1. All dimensions are in meters unless noted otherwise.
 2. All levels are in meters above ordnance datum.
 3. All details shown on this drawing are indicative only and subject to further development at specimen design stage. NOT FOR CONSTRUCTION.
 4. This drawing shall be read in conjunction with the 'Watercourse Crossing report' only and not in isolation.
 5. All 'new' and 'extended' culverts have been designed in accordance with the relevant provisions of DMRB.
 6. Where required 'scour protection measures' shall be provided within the zone of scour influence as indicated on the drawing. The nature and the extent of the scour protection measure will be further developed at specimen design stage in accordance with the relevant provisions of DMRB and relevant Good Practice Guides, taking into account flow hydraulics, channel geometry and channel morphology. This may include the provision of scour pools / stilling basin appropriately designed on a site by site basis.
 7. Where shown culverts shall be 'embedded' with natural river deposits to the depth shown.
 8. Where shown 'cascades' are required to safely convey the design flood event (0.5% AEP (200-year) plus allowance for climate change). The cascade geometry shown on the drawing is indicative only and will be subject to further development at specimen design stage. The nature of the cascade will take one of the following general forms:
 - Bedrock channel cascade.
 - Natural cascade with natural gravels, cobbles and rock forming individual steps.
 - Concrete cascade with stone pitching.
 The nature of the cascade will be determined at the specimen design stage taking into account hydraulic requirements, topography and nature of the underlying strata and its susceptibility to fluvial erosion.
 9. Where shown mammal ledges will be provided within the culvert in accordance with the relevant provisions of DMRB.

SCHEMATIC PLAN

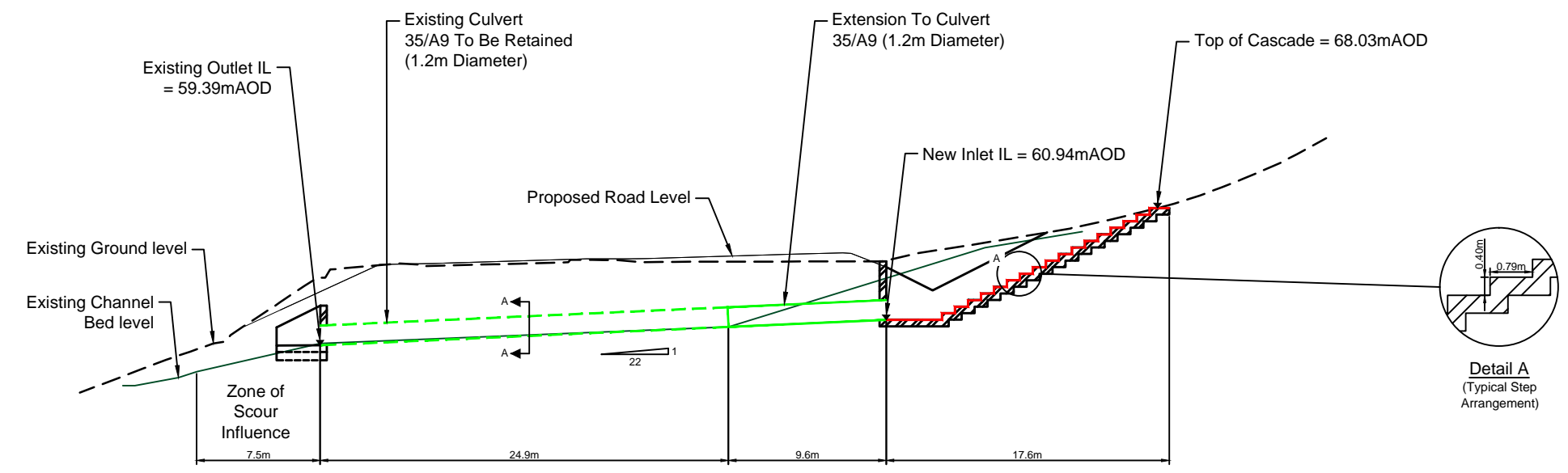
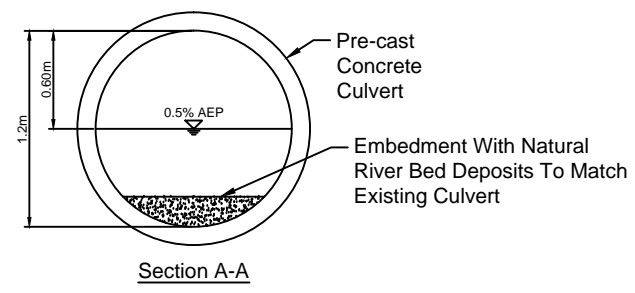

WATERCOURSE 35 LONGSECTION

| 0 | 29/01/2018 | FOR INFORMATION | KL | KA | LMGG | |
|-----|------------|---------------------|-------|---------|-------|---------|
| Rev | Rev. Date | Purpose of revision | Drawn | Checked | Rev'd | Apprv'd |



Drawing title
**TAY CROSSING TO BALLINLUIG
 PROPOSED MODIFICATIONS
 TO CULVERT ON
 WATERCOURSE WF35**

| | | |
|-----------------------------------|-----------------|--------------|
| Drawing status FOR INFORMATION | | |
| Scale | NTS @ A1 | DO NOT SCALE |
| Jacobs No. | B2140003 | |
| Drawing number | Figure A11.8.16 | Rev 0 |

Reproduced by permission of Ordnance Survey on behalf of HMSO. © Crown copyright and database right 2017. All rights reserved. Ordnance Survey Licence number 100046668.

© Copyright 2015 Jacobs U.K. Limited. This concepts and information contained in this document are the property of Jacobs. Use or copying of this document in whole or in part without the written permission of Jacobs constitutes an infringement of copyright. Limitation: This drawing has been prepared on behalf of, and for the exclusive use of Jacobs' Client, and is subject to, and issued in accordance with, the provisions of the contract between Jacobs and the Client. Jacobs accepts no liability or responsibility whatsoever for, or in respect of, any use of, or reliance upon, this drawing by any third party.

File: P:\Data\3B2140003 A9 Tay Crossing to Ballinluig\STAGE 3\EGN - Environmental General\A9P03-JAC-SBR-A_ML042_ST-DR-ST-0001_APP_A1.1.8_FIG17.dwg Date: Jul 18, 2018 - 2:12pm Plotted by: kellyjb

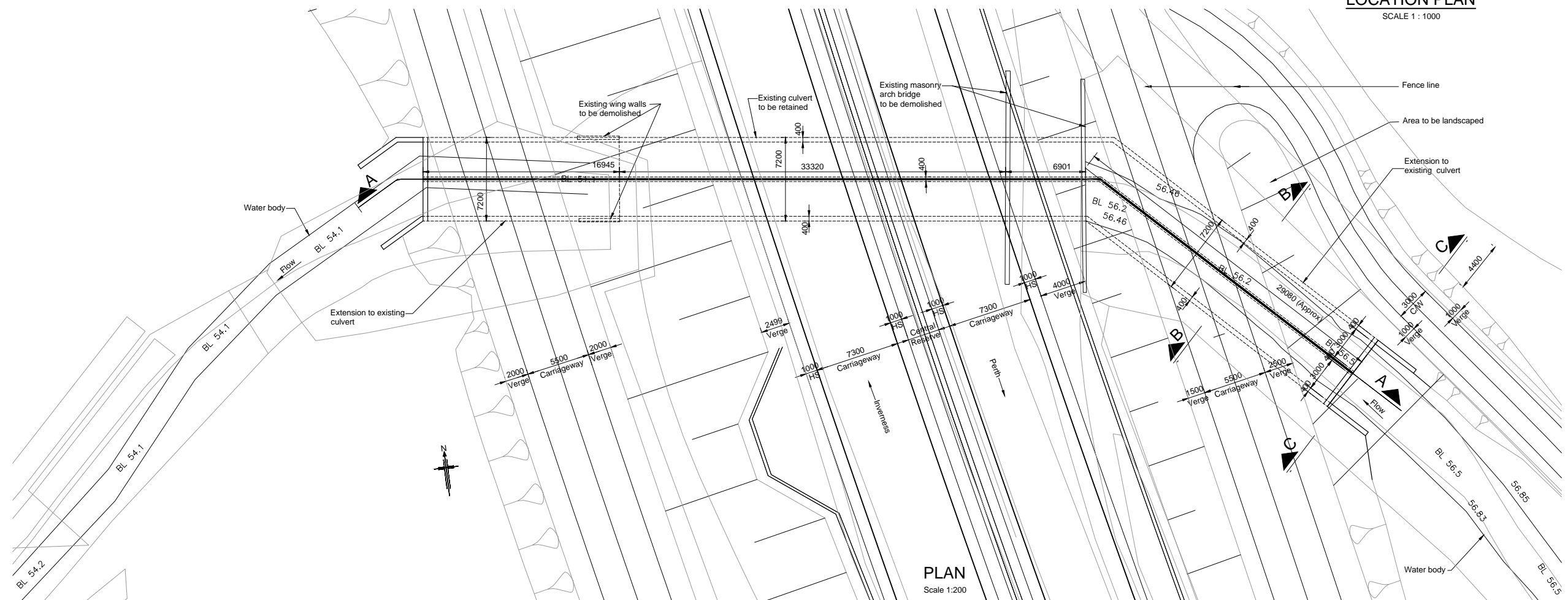
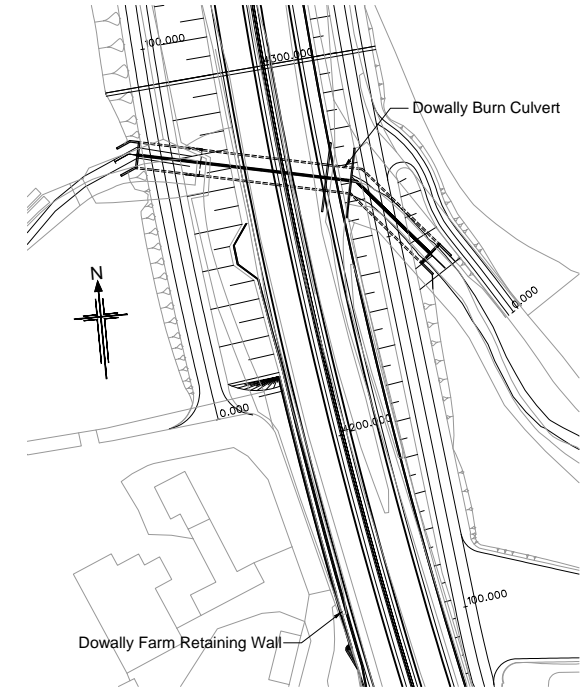
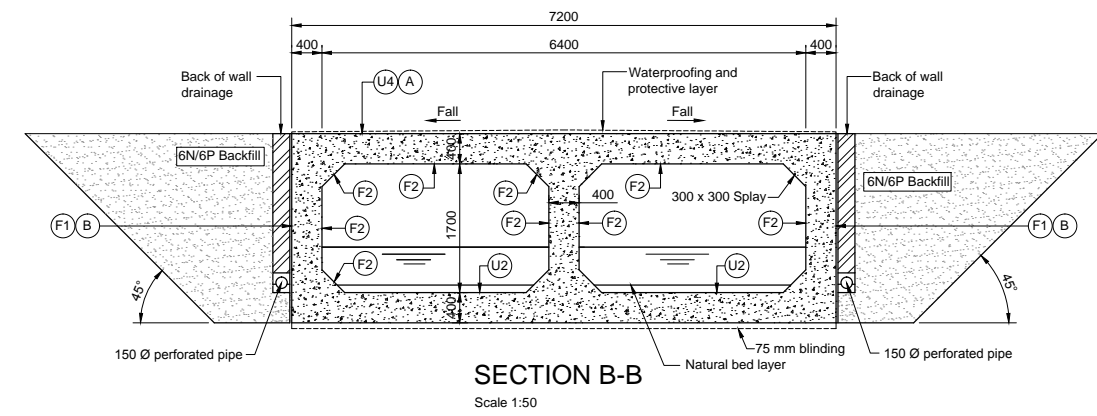
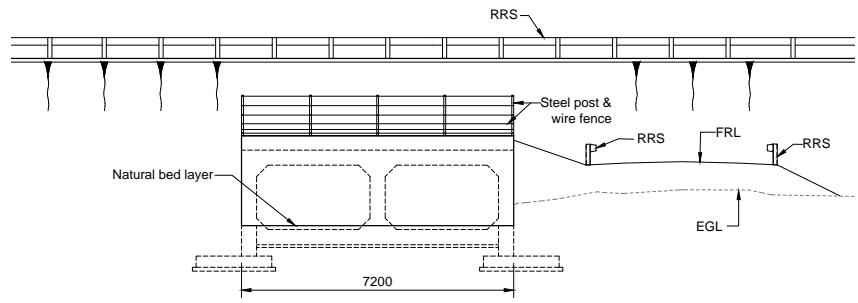
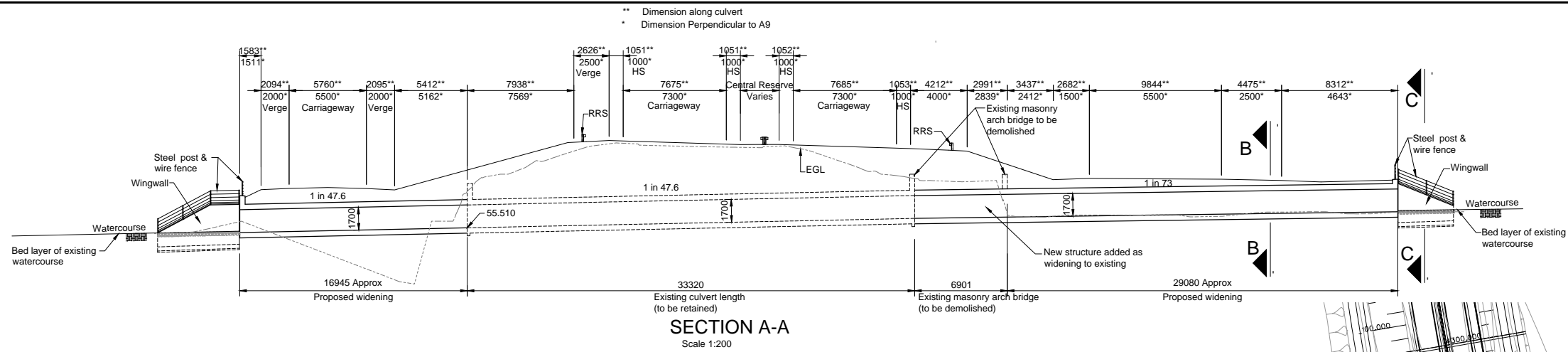

- Notes:
- All dimensions are in millimetres unless noted otherwise.
 - All levels are in metres Above Ordnance Datum.
 - All chainages are in metres.
 - All exposed arrises to have 25x25 chamfers unless noted otherwise.
 - All details shown on this drawing are indicative only and subject to development.
 - Concrete finishes as noted below:
 - (F) - Formed
 - (U) - Unformed
 - Concrete protection to be as follows:
 - (S) - Surface impregnation in accordance with DB43 of the DMRB.
 - (A) - Spray applied waterproofing in accordance with Cl. 2003 of the Specifications.
 - (B) - Waterproofing of all buried surfaces in accordance with Cl. 2004 of the Specification.
 - Length of existing culvert to be verified at detailed design stage.

| SAFETY, HEALTH AND ENVIRONMENTAL INFORMATION | |
|---|--|
| In addition to the hazards/risks normally associated with the types of work detailed on this drawing, note the following: | |
| CONSTRUCTION | |
| <ul style="list-style-type: none"> • Service survey required pre-construction • Potential presence in existing structure of harmful substances causing damage to health to be established pre-demolition. • Structure stability to be checked during break-out / demolition of existing structure • Position of existing structure may not be as shown • Nature and position of the existing structure foundations to be verified pre-construction by undertaking investigations • Condition of existing structure may not be as anticipated. • Existing structure may not be accurately represented by record drawings. | |
| MAINTENANCE / CLEANING | |
| -None | |
| DECOMMISSIONING / DEMOLITION | |
| -None | |
| It is assumed that all works will be carried out by a competent contractor working, where appropriate, to an approved method statement. | |

Reproduced by permission of Ordnance Survey on behalf of HMSO. © Crown copyright and database right 2018. All rights reserved. Ordnance Survey Licence number 100046668.

| Rev | Rev. Date | Purpose of revision | Drawn | Checked | Rev'd | Apprv'd |
|-----|------------|-----------------------------------|-------|---------|-------|---------|
| P3 | 11/07/2018 | Design Fix 8A - Issued for Review | US | KSR | MAM | |
| P2 | 04/05/2018 | Design Fix 7 - Issued for Review | PSR | KSR | MAM | KS |
| P1 | 11/10/2017 | Design Fix 4 - Issued for Review | US | KSR | MAM | KLPS |

JACOBS
95 Bothwell St, Glasgow, G2 7HX
Tel: +44(0)141 243 8000 Fax: +44(0)141 226 3109
www.jacobs.com



Client: **DMRB STAGE 3 TAY CROSSING TO BALLINLUIG DOWALLY BURN CULVERT GENERAL ARRANGEMENT**

| Drawing status | |
|-----------------|-------------------|
| FOR INFORMATION | |
| Scale | @ A1 DO NOT SCALE |
| Jacobs No. | B2140003 |
| Drawing number | Figure A11.8.17 |
| Rev | P3 |

© Copyright 2015 Jacobs U.K. Limited. The concepts and information contained in this document are the property of Jacobs. Use or copying of this document in whole or in part without the written permission of Jacobs constitutes an infringement of copyright. Limitation: This drawing has been prepared on behalf of, and for the exclusive use of, the Client, and is subject to, and issued in accordance with, the provisions of the contract between Jacobs and the Client. Jacobs accepts no liability or responsibility whatsoever for, or in respect of, any use of, or reliance upon, this drawing by any third party.

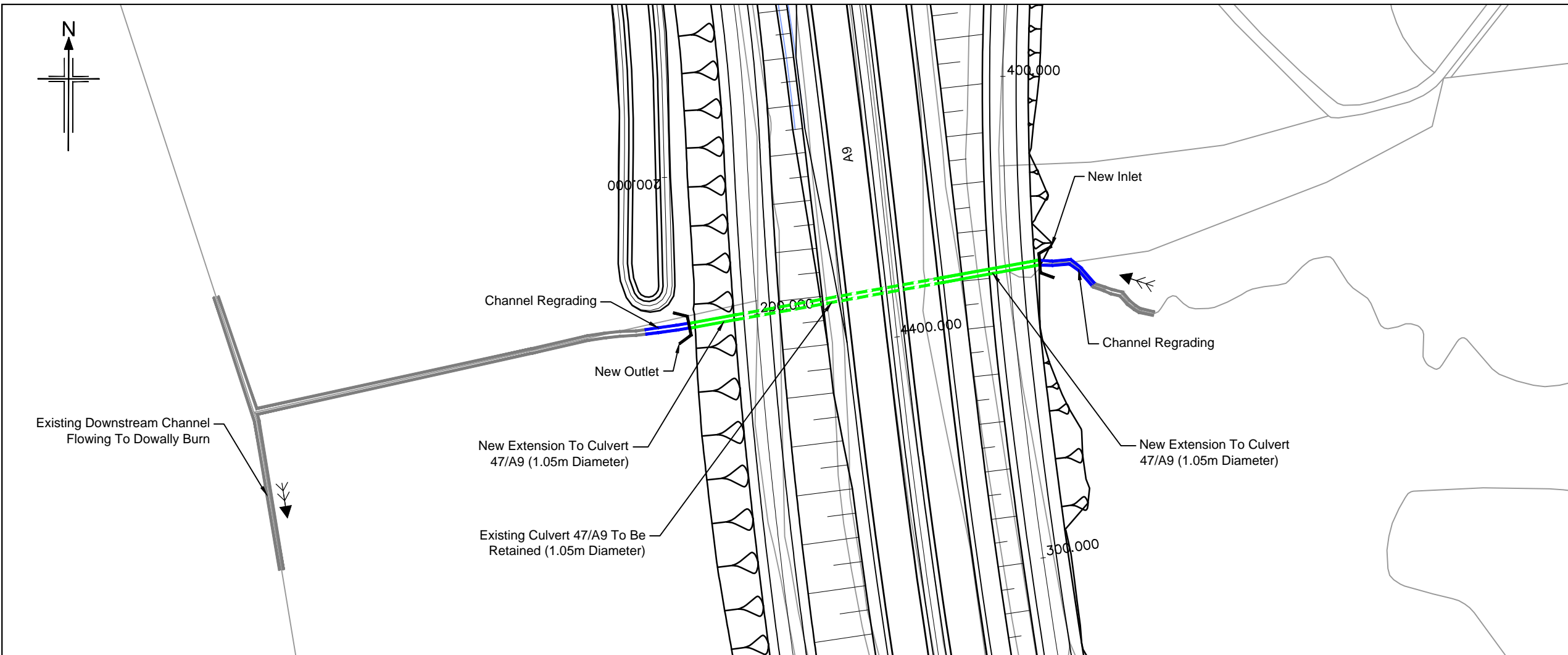

- Legend:**
- New culvert/extension
 - - - Retained culvert
 - Realigned/regraded channel
 - Cascade
 - Inlet/outlet headwall (new)
 - Inlet/outlet headwall (retained)
 - Pre-earthworks drain and outfall
 - Access chamber
 - Flow direction
 - IL

- Notes:**
1. All dimensions are in meters unless noted otherwise.
 2. All levels are in meters above ordnance datum.
 3. All details shown on this drawing are indicative only and subject to further development at specimen design stage. NOT FOR CONSTRUCTION.
 4. This drawing shall be read in conjunction with the 'Watercourse Crossing report' only and not in isolation.
 5. All 'new' and 'extended' culverts have been designed in accordance with the relevant provisions of DMRB.
 6. Where required 'scour protection measures' shall be provided within the zone of scour influence as indicated on the drawing. The nature and the extent of the scour protection measure will be further developed at specimen design stage in accordance with the relevant provisions of DMRB and relevant Good Practice Guides, taking into account flow hydraulics, channel geometry and channel morphology. This may include the provision of scour pools / stilling basin appropriately designed on a site by site basis.
 7. Where shown culverts shall be 'embedded' with natural river deposits to the depth shown.
 8. Where shown 'cascades' are required to safely convey the design flood event (0.5% AEP (200-year) plus allowance for climate change). The cascade geometry shown on the drawing is indicative only and will be subject to further development at specimen design stage. The nature of the cascade will take one of the following general forms:
 - Bedrock channel cascade.
 - Natural cascade with natural gravels, cobbles and rock forming individual steps.
 - Concrete cascade with stone pitching.
 The nature of the cascade will be determined at the specimen design stage taking into account hydraulic requirements, topography and nature of the underlying strata and its susceptibility to fluvial erosion.
 9. Where shown mammal ledges will be provided within the culvert in accordance with the relevant provisions of DMRB.

SCHEMATIC PLAN

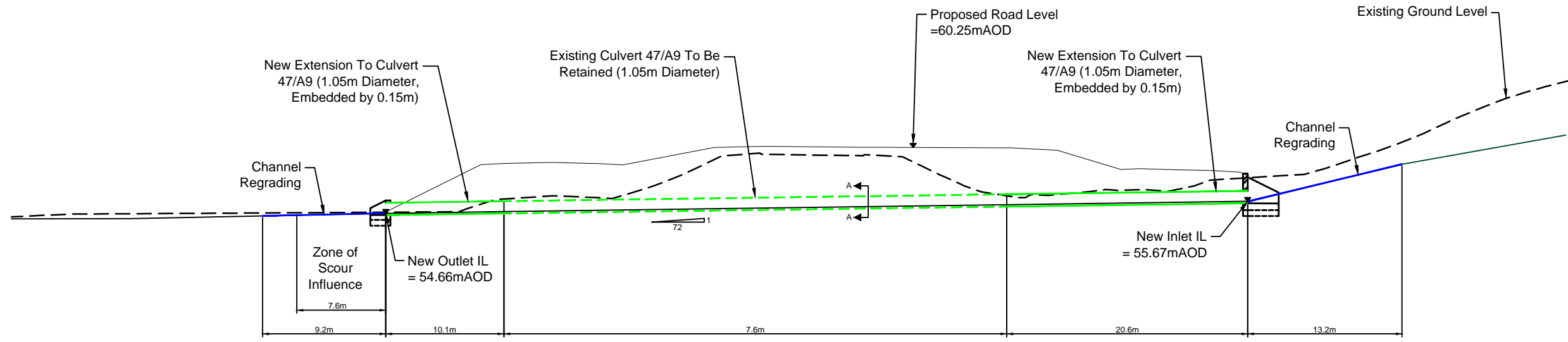
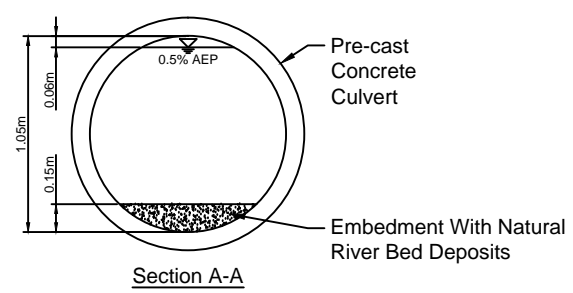

WATERCOURSE 37 LONGSECTION

| Rev | Rev. Date | Purpose of revision | Drawn | Checked | Rev'd | Appr'd |
|-----|------------|---------------------|-------|---------|-------|--------|
| 0 | 29/01/2018 | FOR INFORMATION | KL | KA | LMGG | |



Drawing title
**TAY CROSSING TO BALLINLUIG
 PROPOSED MODIFICATIONS
 TO CULVERT ON
 WATERCOURSE WF37**

Drawing status: **FOR INFORMATION**

| | | |
|----------------|-----------------|--------------|
| Scale | NTS @ A1 | DO NOT SCALE |
| Jacobs No. | B2140003 | |
| Drawing number | Figure A11.8.18 | |
| Rev | 0 | |

Reproduced by permission of Ordnance Survey on behalf of HMSO. © Crown copyright and database right 2017. All rights reserved. Ordnance Survey Licence number 100046668.

© Copyright 2015 Jacobs U.K. Limited. The concepts and information contained in this document are the property of Jacobs. Use or copying of this document in whole or in part without the written permission of Jacobs constitutes an infringement of copyright. Limitation: This drawing has been prepared on behalf of, and for the exclusive use of, Jacobs' Client, and is subject to, and issued in accordance with, the provisions of the contract between Jacobs and the Client. Jacobs accepts no liability or responsibility whatsoever for, or in respect of, any use of, or reliance upon, this drawing by any third party.

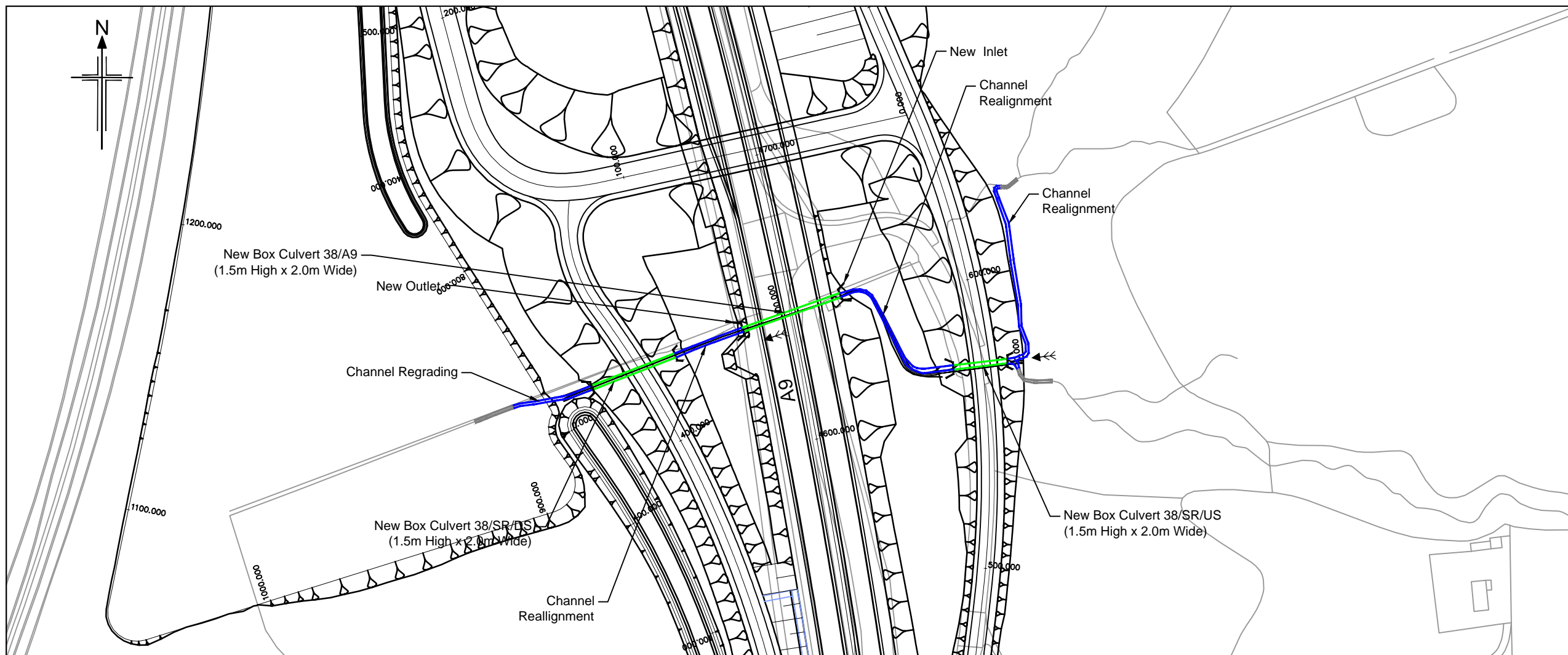

- Legend:
- New culvert/extension
 - - - Retained culvert
 - Realigned/regraded channel
 - Cascade
 - Inlet/outlet headwall (new)
 - Inlet/outlet headwall (retained)
 - Pre-earthworks drain and outfall
 - Access chamber
 - Flow direction
 - IL

- Notes:
1. All dimensions are in meters unless noted otherwise.
 2. All levels are in meters above ordnance datum.
 3. All details shown on this drawing are indicative only and subject to further development at specimen design stage. NOT FOR CONSTRUCTION.
 4. This drawing shall be read in conjunction with the 'Watercourse Crossing report' only and not in isolation.
 5. All 'new' and 'extended' culverts have been designed in accordance with the relevant provisions of DMRB.
 6. Where required 'scour protection measures' shall be provided within the zone of scour influence as indicated on the drawing. The nature and the extent of the scour protection measure will be further developed at specimen design stage in accordance with the relevant provisions of DMRB and relevant Good Practice Guides, taking into account flow hydraulics, channel geometry and channel morphology. This may include the provision of scour pools / stilling basin appropriately designed on a site by site basis.
 7. Where shown culverts shall be 'embedded' with natural river deposits to the depth shown.
 8. Where shown 'cascades' are required to safely convey the design flood event (0.5% AEP (200-year) plus allowance for climate change). The cascade geometry shown on the drawing is indicative only and will be subject to further development at specimen design stage. The nature of the cascade will take one of the following general forms:
 - Bedrock channel cascade.
 - Natural cascade with natural gravels, cobbles and rock forming individual steps.
 - Concrete cascade with stone pitching.
 The nature of the cascade will be determined at the specimen design stage taking into account hydraulic requirements, topography and nature of the underlying strata and its susceptibility to fluvial erosion.
 9. Where shown mammal ledges will be provided within the culvert in accordance with the relevant provisions of DMRB.

SCHEMATIC PLAN

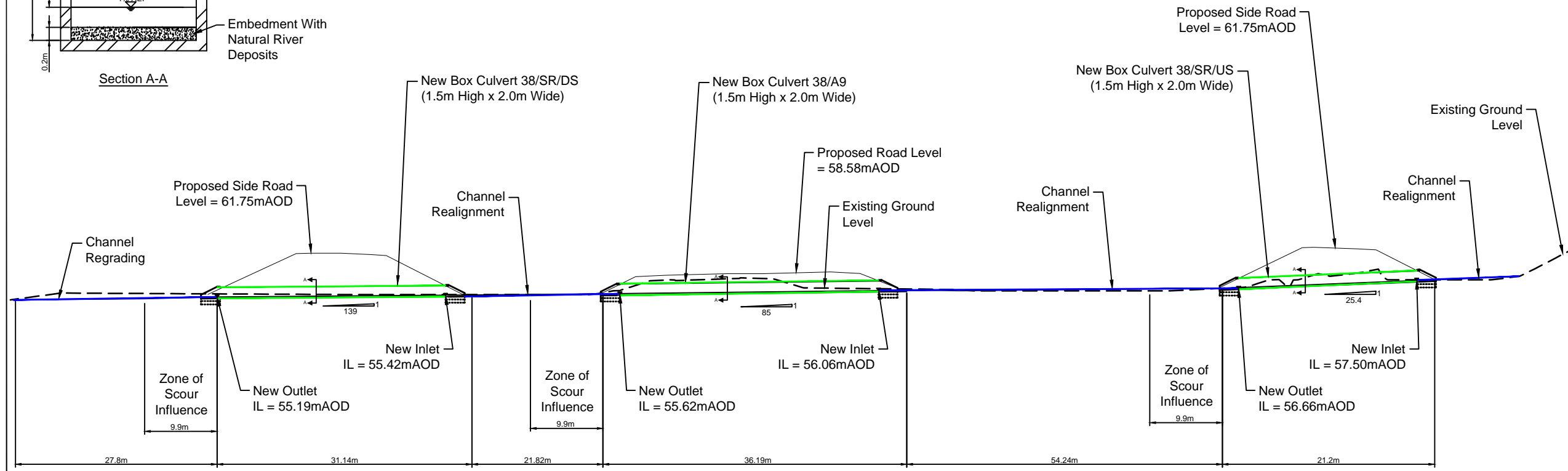
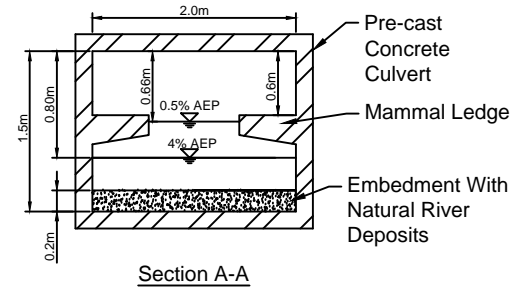

WATERCOURSE 38 LONGSECTION

| Rev | Rev. Data | Purpose of revision | Drawn | Checked | Rev'd | Apprv'd |
|-----|------------|---------------------|-------|---------|-------|---------|
| 0 | 29/01/2018 | FOR INFORMATION | KL | KA | LMGG | |



Drawing title
**TAY CROSSING TO BALLINLUIG
 PROPOSED MODIFICATIONS
 TO CULVERT ON
 WATERCOURSE WF38**

Drawing status
FOR INFORMATION

Scale: NTS @ A1 DO NOT SCALE
 Jacobs No.: B2140003
 Drawing number: Figure A11.8.19

Rev: 0

Reproduced by permission of Ordnance Survey on behalf of HMSO. © Crown copyright and database right 2017. All rights reserved. Ordnance Survey Licence number 100046668.

© Copyright 2015 Jacobs U.K. Limited. The concepts and information contained in this document are the property of Jacobs. Use or copying of this document in whole or in part without the written permission of Jacobs constitutes an infringement of copyright. Limitation: This drawing has been prepared on behalf of, and for the exclusive use of, Jacobs' Client, and is subject to, and issued in accordance with, the provisions of the contract between Jacobs and the Client. Jacobs accepts no liability or responsibility whatsoever for, or in respect of, any use of, or reliance upon, this drawing by any third party.

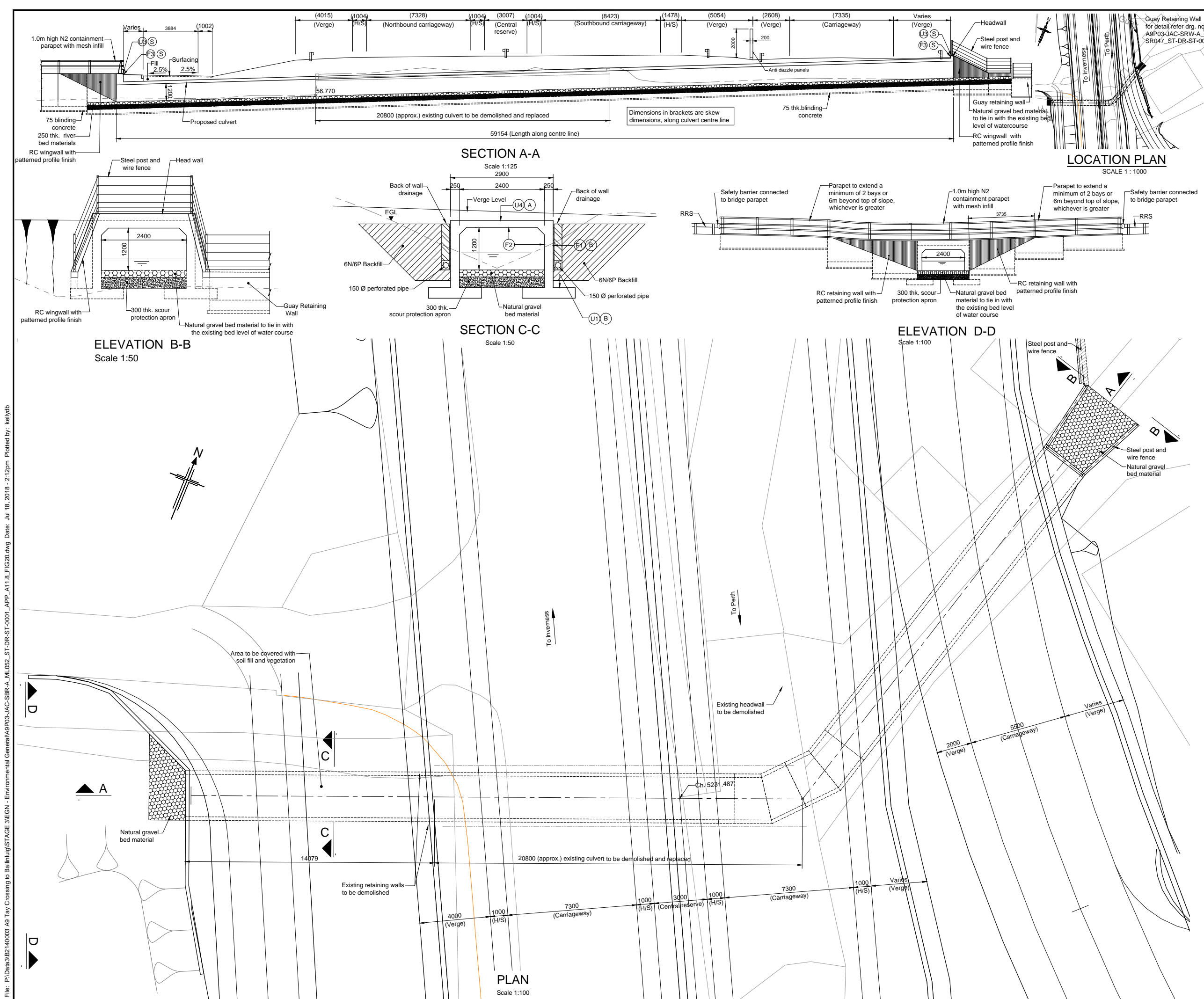

- Notes:
- All dimensions are in millimetres unless noted otherwise.
 - All levels are in metres Above Ordnance Datum.
 - All changes are in metres.
 - All exposed arrises to have 25x25 chamfers unless noted otherwise.
 - All details shown on this drawing are indicative only and subject to development.
 - Concrete finishes as noted below:
 - (F) - Formed
 - (U) - Unformed
 - Concrete protection to be as follows:
 - (S) - Surface impregnation in accordance with DB43 of the DMRB.
 - (A) - Spray applied waterproofing in accordance with Cl. 2003 of the Specifications.
 - (B) - Waterproofing of all buried surfaces in accordance with Cl. 2004 of the Specification.

| SAFETY, HEALTH AND ENVIRONMENTAL INFORMATION | |
|--|--|
| In addition to the hazards/risks normally associated with the types of work detailed on this drawing, note the following: | |
| CONSTRUCTION | |
| <ul style="list-style-type: none"> Service survey required pre-construction Potential presence in existing structure of harmful substances causing damage to health to be established pre-demolition Structure stability to be checked during break-out / demolition of existing structure Position of existing structure may not be as shown Nature and position of the existing structure foundations to be verified pre-construction by undertaking investigations Condition of existing structure may not be as anticipated. Existing structure may not be accurately represented by record drawings. | |
| MAINTENANCE / CLEANING | |
| -None | |
| DECOMMISSIONING / DEMOLITION | |
| -None | |
| It is assumed that all works will be carried out by a competent contractor working, where appropriate, to an approved method statement. | |

Reproduced by permission of Ordnance Survey on behalf of HMSO. © Crown copyright and database right 2018. All rights reserved. Ordnance Survey Licence number 100046668.

| Rev | Rev. Date | Purpose of revision | Drawn | Checked | Rev'd | App'd |
|-----|------------|-----------------------------------|-------|---------|-------|-------|
| P3 | 16/07/2018 | Design Fix 6A - Issued for Review | PSR | KSR | MA | Mills |
| P2 | 04/05/2018 | Design Fix 7 - Issued for Review | PSR | KSR | MAM | |
| P1 | 11/10/2017 | Design Fix 4 - Issued for Review | PSR | SRK | MA | Mills |

JACOBS
95 Bothwell St, Glasgow, G2 7HX
Tel: +44(0)141 243 8000 Fax: +44(0)141 226 3109
www.jacobs.com



Drawing title
**DMRB STAGE 3
TAY CROSSING TO BALLINLUIG
GUAY CULVERT
GENERAL ARRANGEMENT**

| Drawing status | |
|-----------------|-------------------|
| FOR INFORMATION | |
| Scale | @ A1 DO NOT SCALE |
| Jacobs No. | B2140003 |
| Drawing number | Figure A11.8.20 |
| Rev | P3 |

© Copyright 2015 Jacobs U.K. Limited. The concepts and information contained in this document are the property of Jacobs. Use or copying of this document in whole or in part without the written permission of Jacobs constitutes an infringement of copyright. Limitation: This drawing has been prepared on behalf of, and for the exclusive use of, Jacobs Client, and is subject to, and issued in accordance with, the provisions of the contract between Jacobs and the Client. Jacobs accepts no liability or responsibility whatsoever for, or in respect of, any use of, or reliance upon, this drawing by any third party.

File: P:\Data\3B2\140003 A9 Tay Crossing to Ballinluig\STAGE 3\EGN - Environmental General\A9P03-JAC-SBR-A_ML052_ST-DR-ST-0001_APP_A11.8_FIG20.dwg Date: Jul 18, 2018 - 2:12pm Plotted by: kellyjb

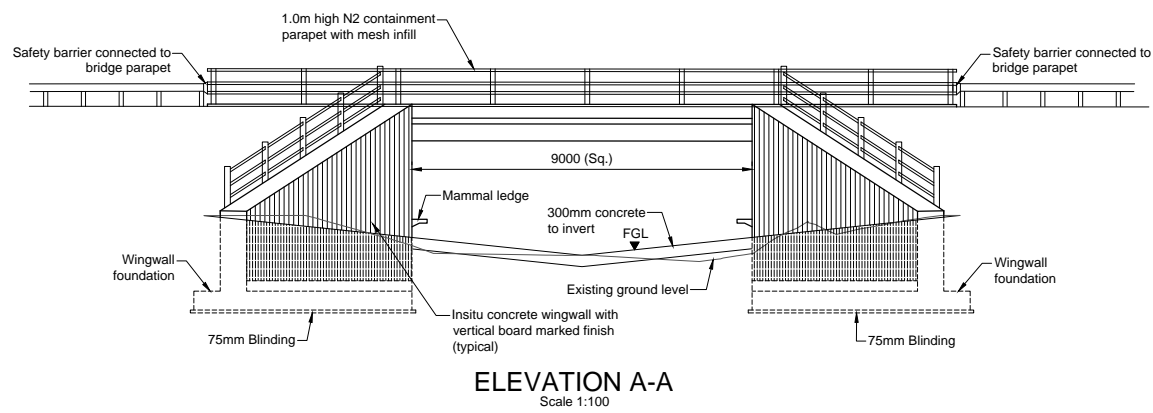

ELEVATION A-A

Scale 1:100

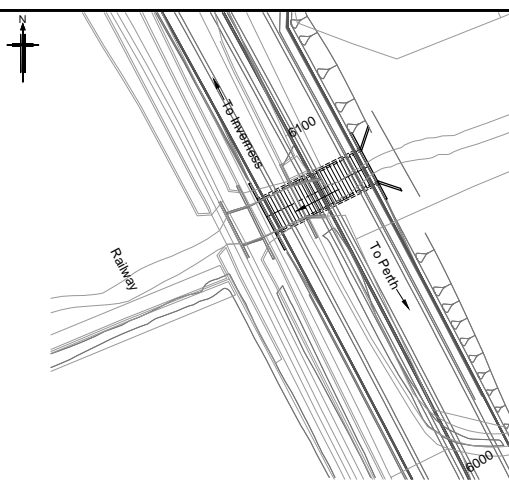

KEY-PLAN

SCALE 1:1000

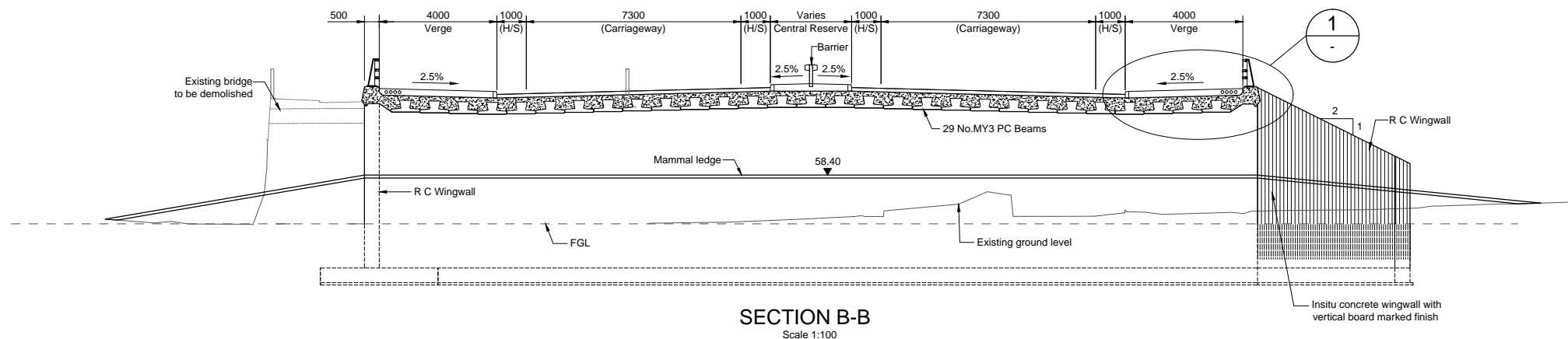

SECTION B-B

Scale 1:100

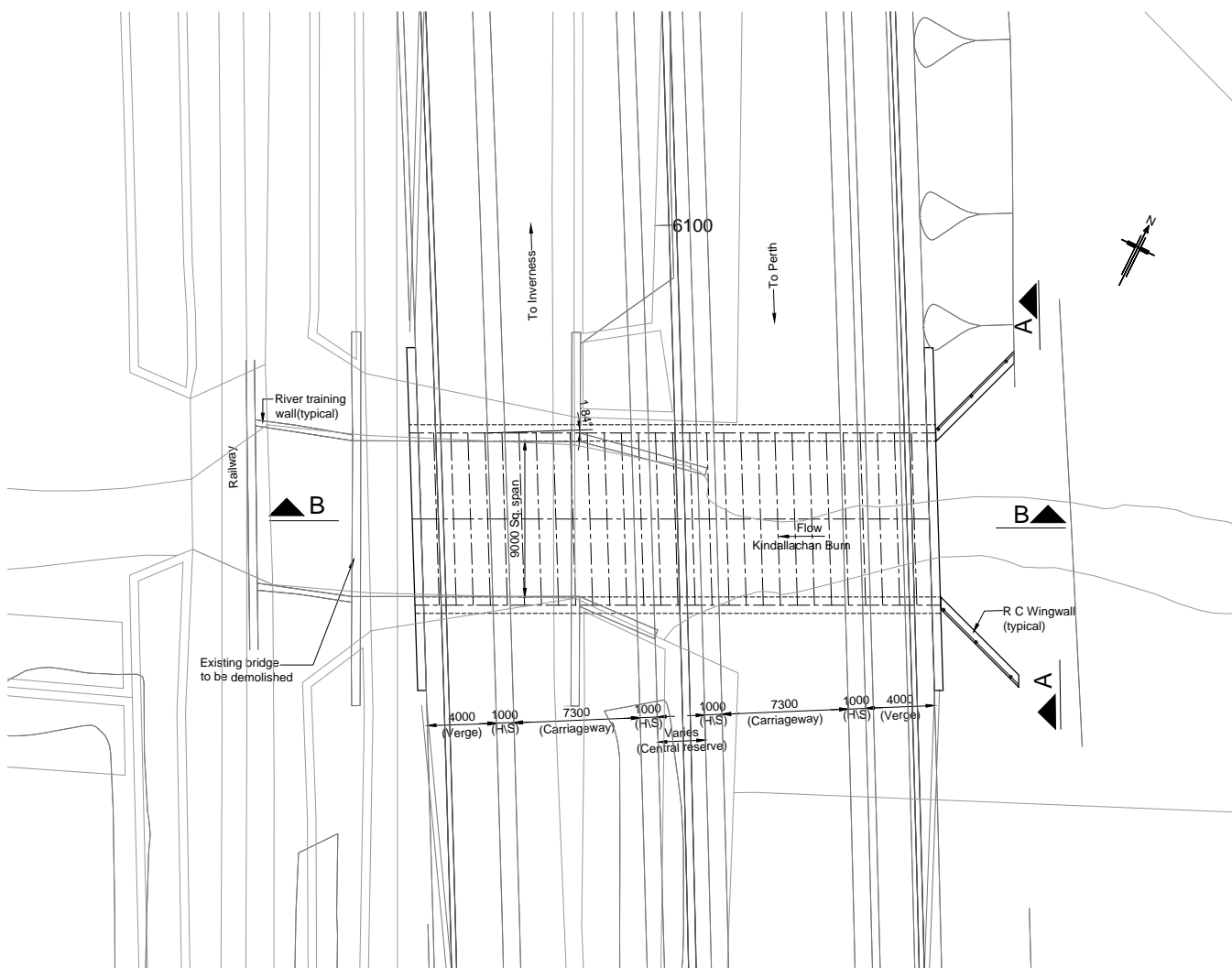

PLAN

SCALE 1:200

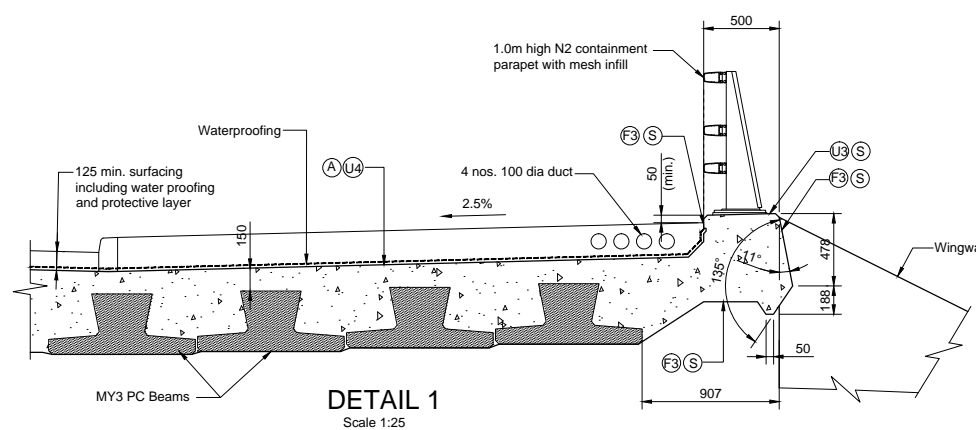

DETAIL 1

Scale 1:25

- Notes:
- All dimensions are in millimetres unless noted otherwise.
 - All levels are in metres Above Ordnance Datum.
 - All chainages are in metres.
 - All exposed arrises to have 25x25 chamfers unless noted otherwise.
 - All details shown on this drawing are indicative only and subject to development.
 - Concrete finishes as noted below:
 - (F) - Formed
 - (U) - Unformed
 - Concrete protection to be as follows:
 - (S) - Surface impregnation in accordance with BD43 of the DMRB.
 - (A) - Spray applied waterproofing in accordance with Cl. 2003 of the Specification.
 - (B) - Waterproofing of all buried surfaces in accordance with Cl. 2004 of the Specification.

| SAFETY, HEALTH AND ENVIRONMENTAL INFORMATION | |
|---|--|
| In addition to the hazards/risks normally associated with the types of work detailed on this drawing, note the following: | |
| CONSTRUCTION | |
| <ul style="list-style-type: none"> Service survey required pre-construction Potential presence in existing structure of harmful substances causing damage to health to be established pre-demolition. Structure stability to be checked during break-out / demolition of existing structure Position of existing structure may not be as shown Nature and position of the existing structure foundations to be verified pre-construction by undertaking investigations Condition of existing structure may not be as anticipated. Existing structure may not be accurately represented by record drawings. | |
| MAINTENANCE / CLEANING | |
| -None | |
| DECOMMISSIONING / DEMOLITION | |
| -None | |
| It is assumed that all works will be carried out by a competent contractor working, where appropriate, to an approved method statement. | |

Reproduced by permission of Ordnance Survey on behalf of HMSO. © Crown copyright and database right 2018. All rights reserved. Ordnance Survey Licence number 100046668.

| P3 | 04/07/2018 | Design Fix 6a - Issued for Review | PSR | SRK | MA Mills | |
|-----|------------|-----------------------------------|-------|---------|----------|-------|
| P2 | 23/05/2018 | Design Fix 7 - Issued for Review | PSR | KSR | MA Mills | KS |
| P1 | 21/09/2017 | Design Fix 4 - Issued for Review | PSR | SRK | MA Mills | KS |
| Rev | Rev. Date | Purpose of revision | Drawn | Checked | Rev'd | App'd |

JACOBS

95 Bothwell St, Glasgow, G2 7HX
Tel: +44(0)141 243 8000 Fax: +44(0)141 226 3109
www.jacobs.com

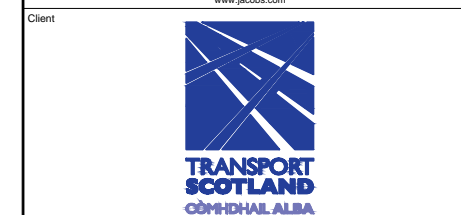

Drawing title
**DMRB STAGE 3
TAY CROSSING TO BALLINLUIG
KINDALLACHAN BURN
UNDERBRIDGE
GENERAL ARRANGEMENT**

Drawing status
FOR INFORMATION

Scale @ A1 DO NOT SCALE

Jacobs No. B2140003

Drawing number **FIGURE A11.8.21** Rev P3

© Copyright 2015 Jacobs U.K. Limited. The concepts and information contained in this document are the property of Jacobs. Use or copying of this document in whole or in part without the written permission of Jacobs constitutes an infringement of copyright. Limitation. This drawing has been prepared on behalf of, and for the exclusive use of Jacobs Client, and is subject to, and issued in accordance with, the provisions of the contract between Jacobs and the Client. Jacobs accepts no liability or responsibility whatsoever for, or in respect of, any use of, or reliance upon, this drawing by any third party.

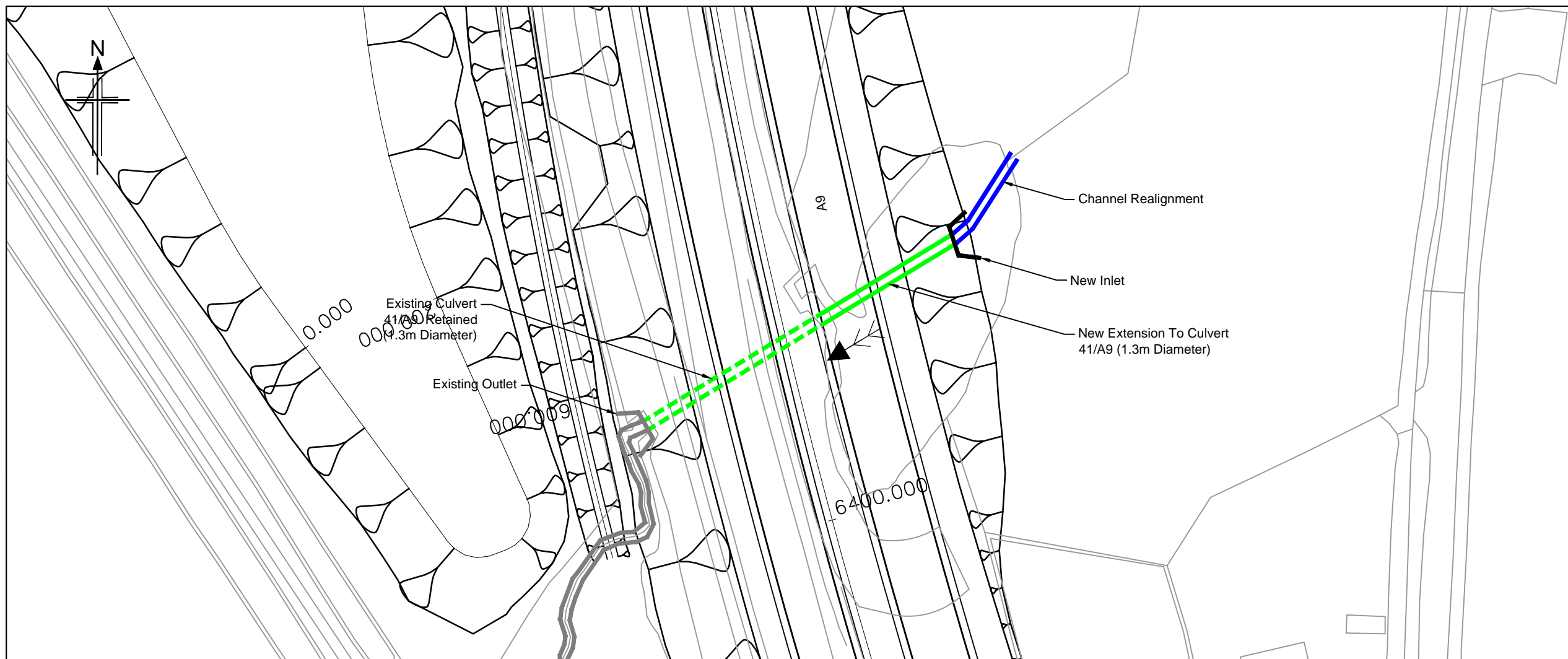

- Legend:
- New culvert/extension
 - - - Retained culvert
 - Realigned/regraded channel
 - Cascade
 - Inlet/outlet headwall (new)
 - Inlet/outlet headwall (retained)
 - Pre-earthworks drain and outfall
 - Access chamber
 - Flow direction
 - Invert Level

- Notes:
1. All dimensions are in meters unless noted otherwise.
 2. All levels are in meters above ordnance datum.
 3. All details shown on this drawing are indicative only and subject to further development at specimen design stage. NOT FOR CONSTRUCTION.
 4. This drawing shall be read in conjunction with the 'Watercourse Crossing report' only and not in isolation.
 5. All 'new' and 'extended' culverts have been designed in accordance with the relevant provisions of DMRB.
 6. Where required 'scour protection measures' shall be provided within the zone of scour influence as indicated on the drawing. The nature and the extent of the scour protection measure will be further developed at specimen design stage in accordance with the relevant provisions of DMRB and relevant Good Practice Guides, taking into account flow hydraulics, channel geometry and channel morphology. This may include the provision of scour pools / stilling basin appropriately designed on a site by site basis.
 7. Where shown culverts shall be 'embedded' with natural river deposits to the depth shown.
 8. Where shown 'cascades' are required to safely convey the design flood event (0.5% AEP (200-year) plus allowance for climate change). The cascade geometry shown on the drawing is indicative only and will be subject to further development at specimen design stage. The nature of the cascade will take one of the following general forms:
 - Bedrock channel cascade.
 - Natural cascade with natural gravels, cobbles and rock forming individual steps.
 - Concrete cascade with stone pitching.
 The nature of the cascade will be determined at the specimen design stage taking into account hydraulic requirements, topography and nature of the underlying strata and its susceptibility to fluvial erosion.
 9. Where shown mammal ledges will be provided within the culvert in accordance with the relevant provisions of DMRB.

SCHMATIC PLAN

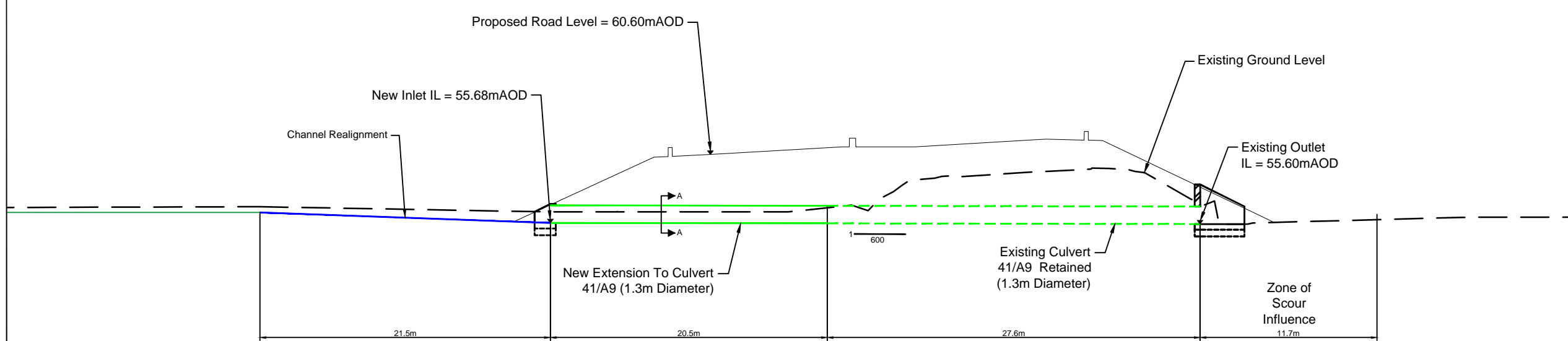
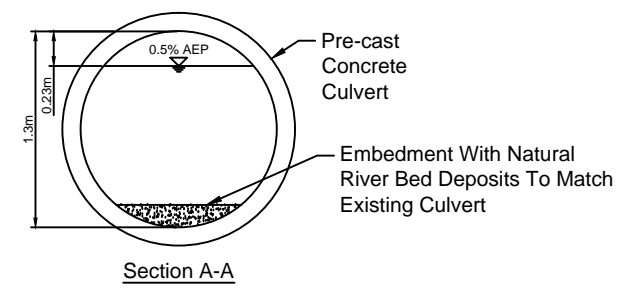

WATERCOURSE 41 LONGSECTION

| 0 | 29/01/2018 | FOR INFORMATION | KL | KA | LMGG | |
|-----|------------|---------------------|-------|---------|-------|--------|
| Rev | Rev. Date | Purpose of revision | Drawn | Checked | Rev'd | Appr'd |



Drawing title
**TAY CROSSING TO BALLINLUIG
 PROPOSED MODIFICATIONS
 TO CULVERT ON
 WATERCOURSE WF41**

Drawing status
FOR INFORMATION

Scale
 NTS @ A1 DO NOT SCALE

Jacobs No. B2140003
 Drawing number
Figure A11.8.22 Rev 0

Reproduced by permission of Ordnance Survey on behalf of HMSO. © Crown copyright and database right 2017. All rights reserved. Ordnance Survey Licence number 100046668.

© Copyright 2015 Jacobs U.K. Limited. The concepts and information contained in this document are the property of Jacobs. Use or copying of this document in whole or in part without the written permission of Jacobs constitutes an infringement of copyright. Limitation: This drawing has been prepared on behalf of, and for the exclusive use of, Jacobs' Client, and is subject to, and issued in accordance with, the provisions of the contract between Jacobs and the Client. Jacobs accepts no liability or responsibility whatsoever for, or in respect of, any use of, or reliance upon, this drawing by any third party.

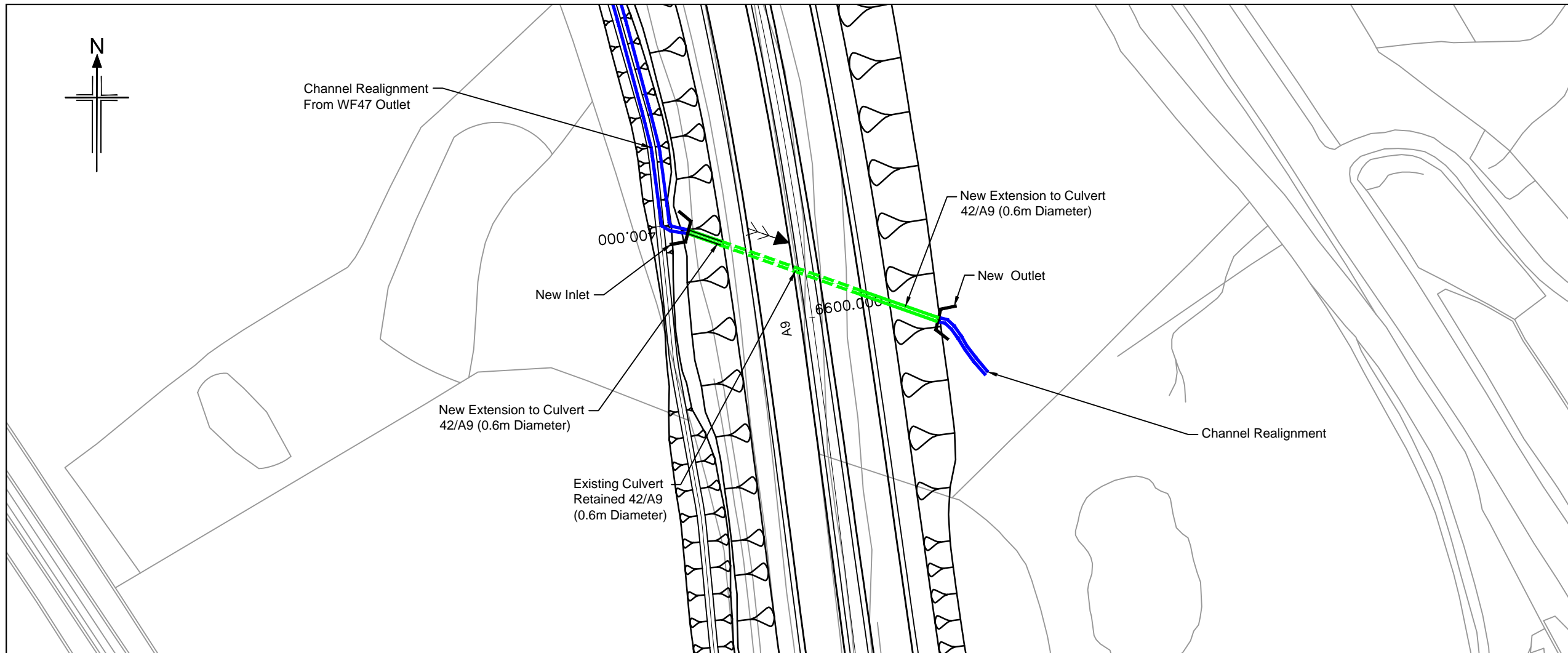

- Legend:
- New culvert/extension
 - - - Retained culvert
 - Realigned/regraded channel
 - Cascade
 - Inlet/outlet headwall (new)
 - Inlet/outlet headwall (retained)
 - Pre-earthworks drain and outfall
 - Access chamber
 - Flow direction
 - Invert Level

- Notes:
1. All dimensions are in meters unless noted otherwise.
 2. All levels are in meters above ordnance datum.
 3. All details shown on this drawing are indicative only and subject to further development at specimen design stage. NOT FOR CONSTRUCTION.
 4. This drawing shall be read in conjunction with the 'Watercourse Crossing report' only and not in isolation.
 5. All 'new' and 'extended' culverts have been designed in accordance with the relevant provisions of DMRB.
 6. Where required 'scour protection measures' shall be provided within the zone of scour influence as indicated on the drawing. The nature and the extent of the scour protection measure will be further developed at specimen design stage in accordance with the relevant provisions of DMRB and relevant Good Practice Guides, taking into account flow hydraulics, channel geometry and channel morphology. This may include the provision of scour pools / stilling basin appropriately designed on a site by site basis.
 7. Where shown culverts shall be 'embedded' with natural river deposits to the depth shown.
 8. Where shown 'cascades' are required to safely convey the design flood event (0.5% AEP (200-year) plus allowance for climate change). The cascade geometry shown on the drawing is indicative only and will be subject to further development at specimen design stage. The nature of the cascade will take one of the following general forms:
 - Bedrock channel cascade.
 - Natural cascade with natural gravels, cobbles and rock forming individual steps.
 - Concrete cascade with stone pitching.
 The nature of the cascade will be determined at the specimen design stage taking into account hydraulic requirements, topography and nature of the underlying strata and its susceptibility to fluvial erosion.
 9. Where shown mammal ledges will be provided within the culvert in accordance with the relevant provisions of DMRB.

SCHMATIC PLAN

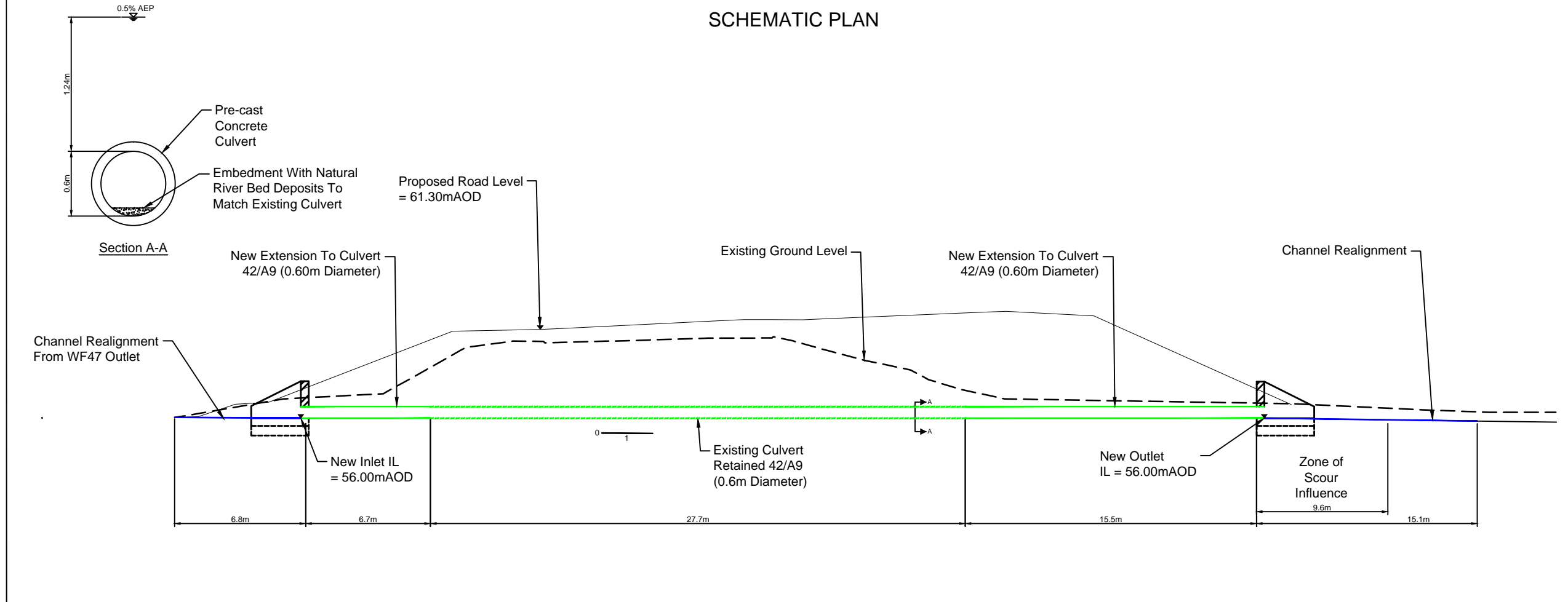

WATERCOURSE 42 LONGSECTION

| 0 | 29/01/2018 | FOR INFORMATION | KL | KA | LMGG | |
|-----|------------|---------------------|-------|---------|-------|---------|
| Rev | Rev. Date | Purpose of revision | Drawn | Checked | Rev'd | Apprv'd |



Drawing title
**TAY CROSSING TO BALLINLUIG
 PROPOSED MODIFICATIONS
 TO CULVERT ON
 WATERCOURSE WF42**

| | | |
|-----------------------------------|-----------------|--------------|
| Drawing status FOR INFORMATION | | |
| Scale | NTS @ A1 | DO NOT SCALE |
| Jacobs No. | B2140003 | |
| Drawing number | Figure A11.8.23 | Rev 0 |

Reproduced by permission of Ordnance Survey on behalf of HMSO. © Crown copyright and database right 2017. All rights reserved. Ordnance Survey Licence number 100046668.

© Copyright 2015 Jacobs U.K. Limited. This concepts and information contained in this document are the property of Jacobs. Use or copying of this document in whole or in part without the written permission of Jacobs constitutes an infringement of copyright. Limitation: This drawing has been prepared on behalf of, and for the exclusive use of Jacobs' Client, and is subject to, and issued in accordance with, the provisions of the contract between Jacobs and the Client. Jacobs accepts no liability or responsibility whatsoever for, or in respect of, any use of, or reliance upon, this drawing by any third party.

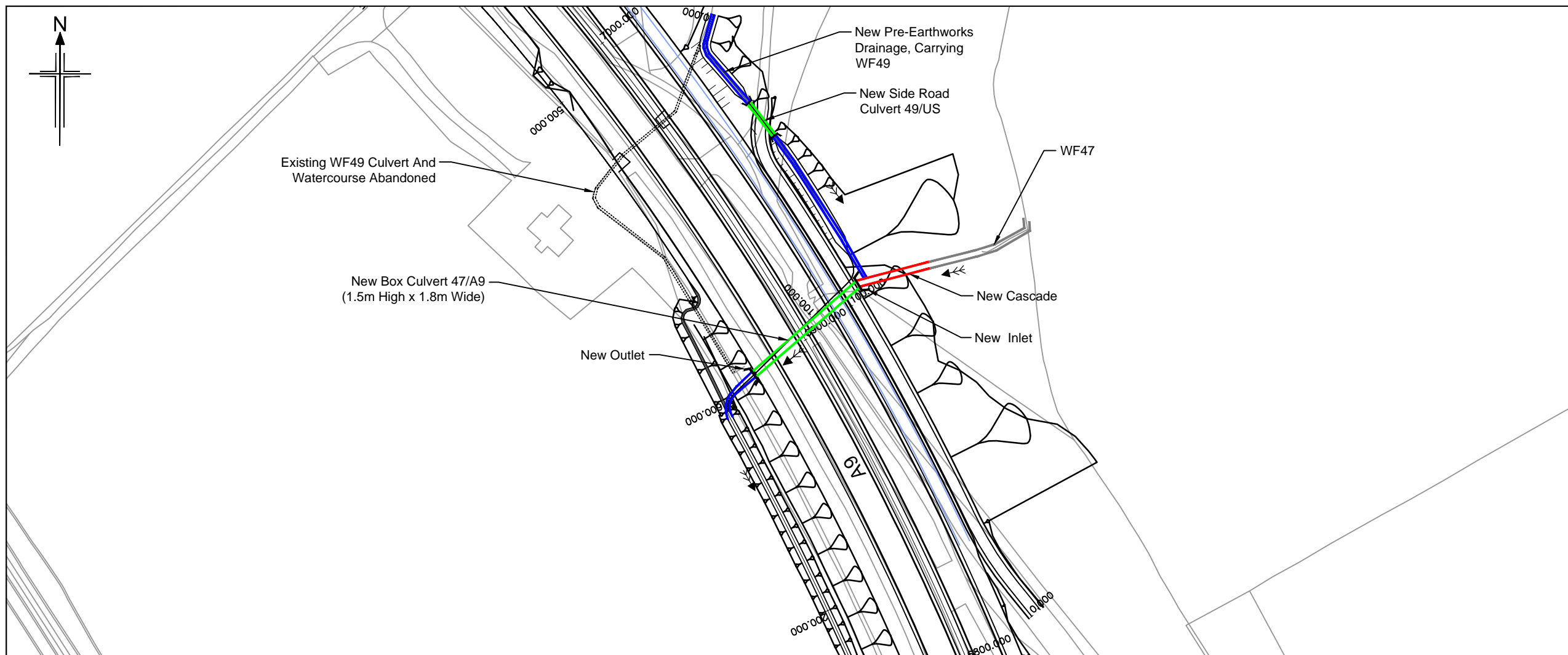

- Legend:
- New culvert/extension
 - - - Retained culvert
 - Realigned/regraded channel
 - Cascade
 - Inlet/outlet headwall (new)
 - - - Inlet/outlet headwall (retained)
 - Pre-earthworks drain and outfall
 - Access chamber
 - ← Flow direction
 - IL Invert Level

- Notes:
1. All dimensions are in meters unless noted otherwise.
 2. All levels are in meters above ordnance datum.
 3. All details shown on this drawing are indicative only and subject to further development at specimen design stage. NOT FOR CONSTRUCTION.
 4. This drawing shall be read in conjunction with the 'Watercourse Crossing report' only and not in isolation.
 5. All 'new' and 'extended' culverts have been designed in accordance with the relevant provisions of DMRB.
 6. Where required 'scour protection measures' shall be provided within the zone of scour influence as indicated on the drawing. The nature and the extent of the scour protection measure will be further developed at specimen design stage in accordance with the relevant provisions of DMRB and relevant Good Practice Guides, taking into account flow hydraulics, channel geometry and channel morphology. This may include the provision of scour pools / stilling basin appropriately designed on a site by site basis.
 7. Where shown culverts shall be 'embedded' with natural river deposits to the depth shown.
 8. Where shown 'cascades' are required to safely convey the design flood event (0.5% AEP (200-year) plus allowance for climate change). The cascade geometry shown on the drawing is indicative only and will be subject to further development at specimen design stage. The nature of the cascade will take one of the following general forms:
 - Bedrock channel cascade.
 - Natural cascade with natural gravels, cobbles and rock forming individual steps.
 - Concrete cascade with stone pitching.
 The nature of the cascade will be determined at the specimen design stage taking into account hydraulic requirements, topography and nature of the underlying strata and its susceptibility to fluvial erosion.
 9. Where shown mammal ledges will be provided within the culvert in accordance with the relevant provisions of DMRB.

SCHEMATIC PLAN

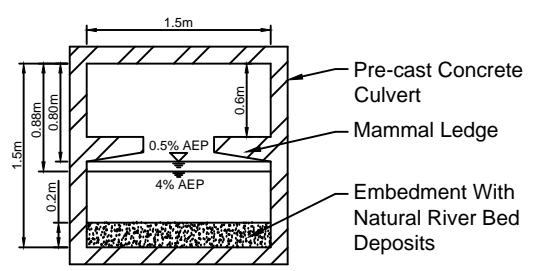

Section A-A

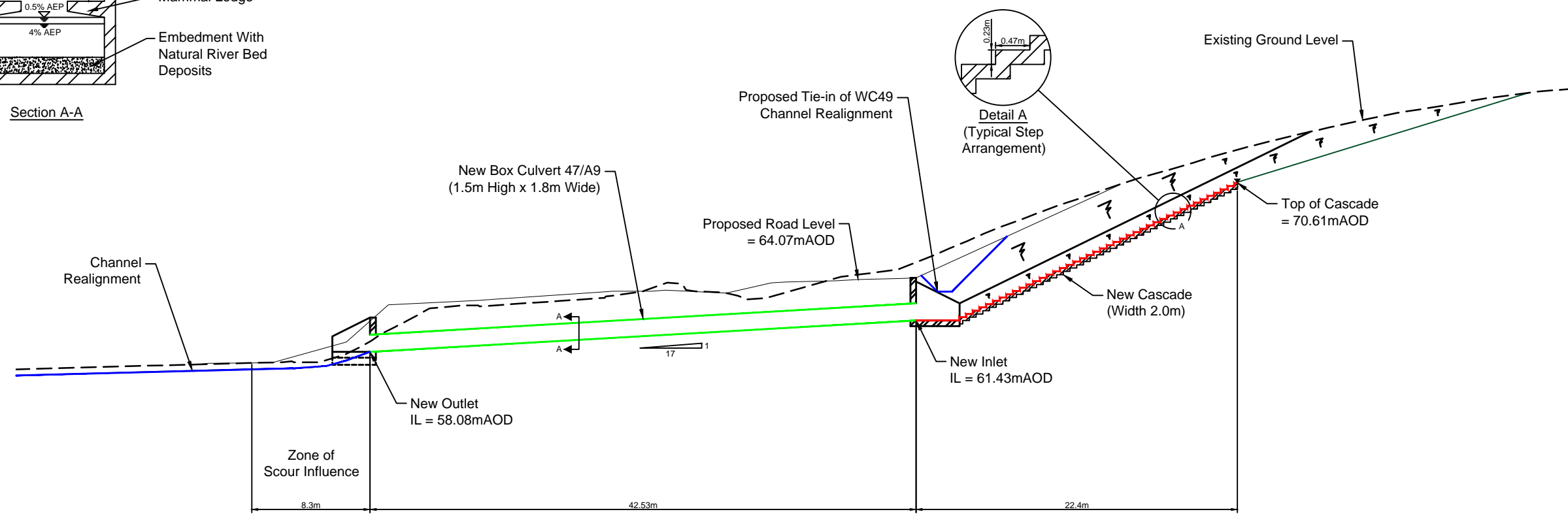

WATERCOURSE 47 LONGSECTION

Reproduced by permission of Ordnance Survey on behalf of HMSO. © Crown copyright and database right 2017. All rights reserved. Ordnance Survey Licence number 100046668.

| 0 | 29/01/2018 | FOR INFORMATION | KL | KA | LMCG | |
|---|------------|---------------------|----------|---------|--------------|-------|
| Rev | Rev. Date | Purpose of revision | Drawn | Checked | Rev'd | App'd |
| 95 Bothwell St, Glasgow, G2 7HX Tel: +44(0)141 243 8000 Fax: +44(0)141 226 3109 www.jacobs.com | | | | | | |
| Client COMHDHALAIBIA | | | | | | |
| Project PERTH TO INVERNESS The Crossing to Ballinluig | | | | | | |
| Drawing title TAY CROSSING TO BALLINLUIG PROPOSED MODIFICATIONS TO CULVERT ON WATERCOURSE WF47 | | | | | | |
| Drawing status FOR INFORMATION | | | | | | |
| Scale | | | NTS @ A1 | | DO NOT SCALE | |
| Jacobs No. | | | B2140003 | | | |
| Drawing number | | | | | | Rev |
| Figure A11.8.24 | | | | | | 0 |
| <small>© Copyright 2015 Jacobs U.K. Limited. The concepts and information contained in this document are the property of Jacobs. Use or copying of this document in whole or in part without the written permission of Jacobs constitutes an infringement of copyright. Limitation: This drawing has been prepared on behalf of, and for the exclusive use of, Jacobs' Client, and is subject to, and issued in accordance with, the provisions of the contract between Jacobs and the Client. Jacobs accepts no liability or responsibility whatsoever for, or in respect of, any use of, or reliance upon, this drawing by any third party.</small> | | | | | | |

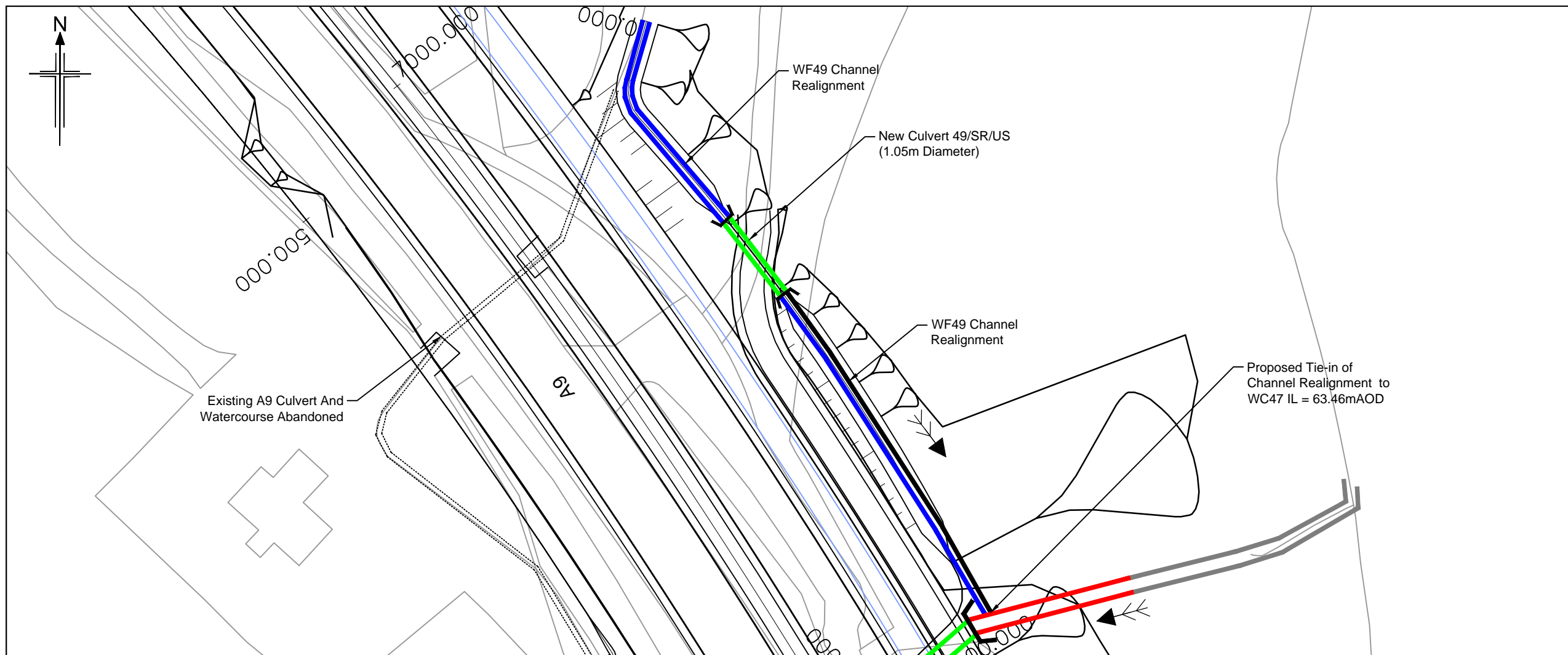

- Legend:
- New culvert/extension
 - - - Retained culvert
 - Realigned/regraded channel
 - Cascade
 - Inlet/outlet headwall (new)
 - Inlet/outlet headwall (retained)
 - Pre-earthworks drain and outfall
 - Access chamber
 - Flow direction
 - IL

- Notes:
1. All dimensions are in meters unless noted otherwise.
 2. All levels are in meters above ordnance datum.
 3. All details shown on this drawing are indicative only and subject to further development at specimen design stage. NOT FOR CONSTRUCTION.
 4. This drawing shall be read in conjunction with the 'Watercourse Crossing report' only and not in isolation.
 5. All 'new' and 'extended' culverts have been designed in accordance with the relevant provisions of DMRB.
 6. Where required 'scour protection measures' shall be provided within the zone of scour influence as indicated on the drawing. The nature and the extent of the scour protection measure will be further developed at specimen design stage in accordance with the relevant provisions of DMRB and relevant Good Practice Guides, taking into account flow hydraulics, channel geometry and channel morphology. This may include the provision of scour pools / stilling basin appropriately designed on a site by site basis.
 7. Where shown culverts shall be 'embedded' with natural river deposits to the depth shown.
 8. Where shown 'cascades' are required to safely convey the design flood event (0.5% AEP (200-year) plus allowance for climate change). The cascade geometry shown on the drawing is indicative only and will be subject to further development at specimen design stage. The nature of the cascade will take one of the following general forms:
 - Bedrock channel cascade.
 - Natural cascade with natural gravels, cobbles and rock forming individual steps.
 - Concrete cascade with stone pitching.
 The nature of the cascade will be determined at the specimen design stage taking into account hydraulic requirements, topography and nature of the underlying strata and its susceptibility to fluvial erosion.
 9. Where shown mammal ledges will be provided within the culvert in accordance with the relevant provisions of DMRB.

SCHEMATIC PLAN

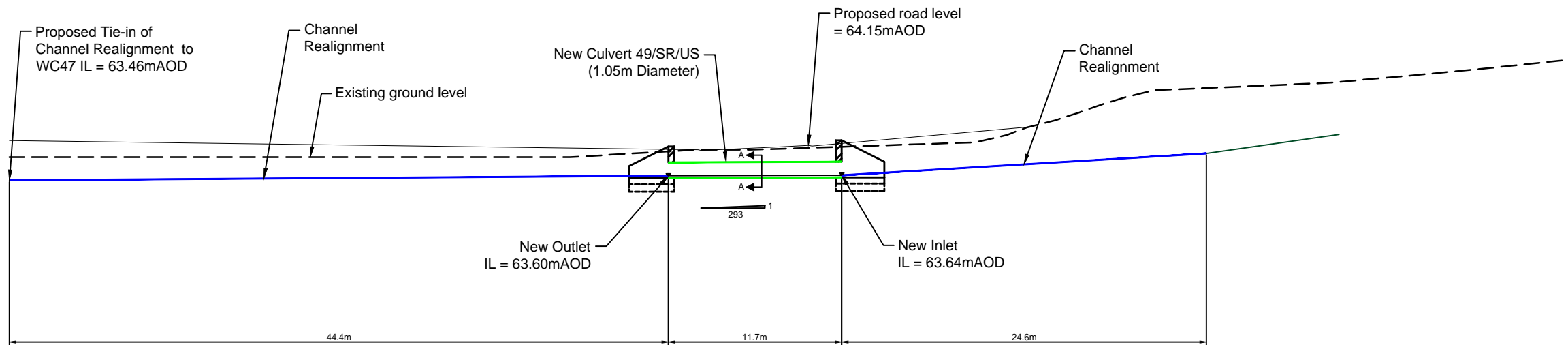
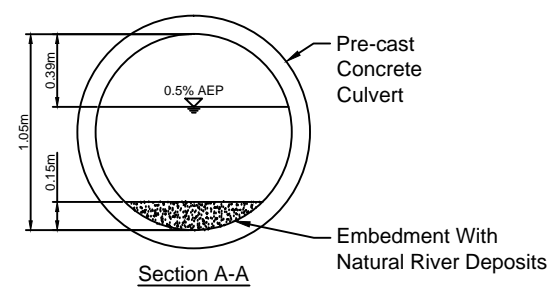

WATERCOURSE 49 LONGSECTION

| 0 | 29/01/2018 | FOR INFORMATION | KL | KA | LMG | |
|-----|------------|---------------------|-------|---------|-------|---------|
| Rev | Rev. Date | Purpose of revision | Drawn | Checked | Rev'd | Apprv'd |



Drawing title
TAY CROSSING TO BALLINLUIG PROPOSED MODIFICATIONS TO CULVERT ON WATERCOURSE WF49

Drawing status
FOR INFORMATION

Scale
 NTS @ A1 DO NOT SCALE

Jacobs No.
 B2140003

Drawing number
Figure A11.8.25

Rev
0

Reproduced by permission of Ordnance Survey on behalf of HMSO. © Crown copyright and database right 2017. All rights reserved. Ordnance Survey Licence number 100046668.

© Copyright 2015 Jacobs U.K. Limited. The concepts and information contained in this document are the property of Jacobs. Use or copying of this document in whole or in part without the written permission of Jacobs constitutes an infringement of copyright. Limitation: This drawing has been prepared on behalf of, and for the exclusive use of, Jacobs' Client, and is issued in accordance with the provisions of the contract between Jacobs and the Client. Jacobs accepts no liability or responsibility whatsoever for, or in respect of, any use of, or reliance upon, this drawing by any third party.

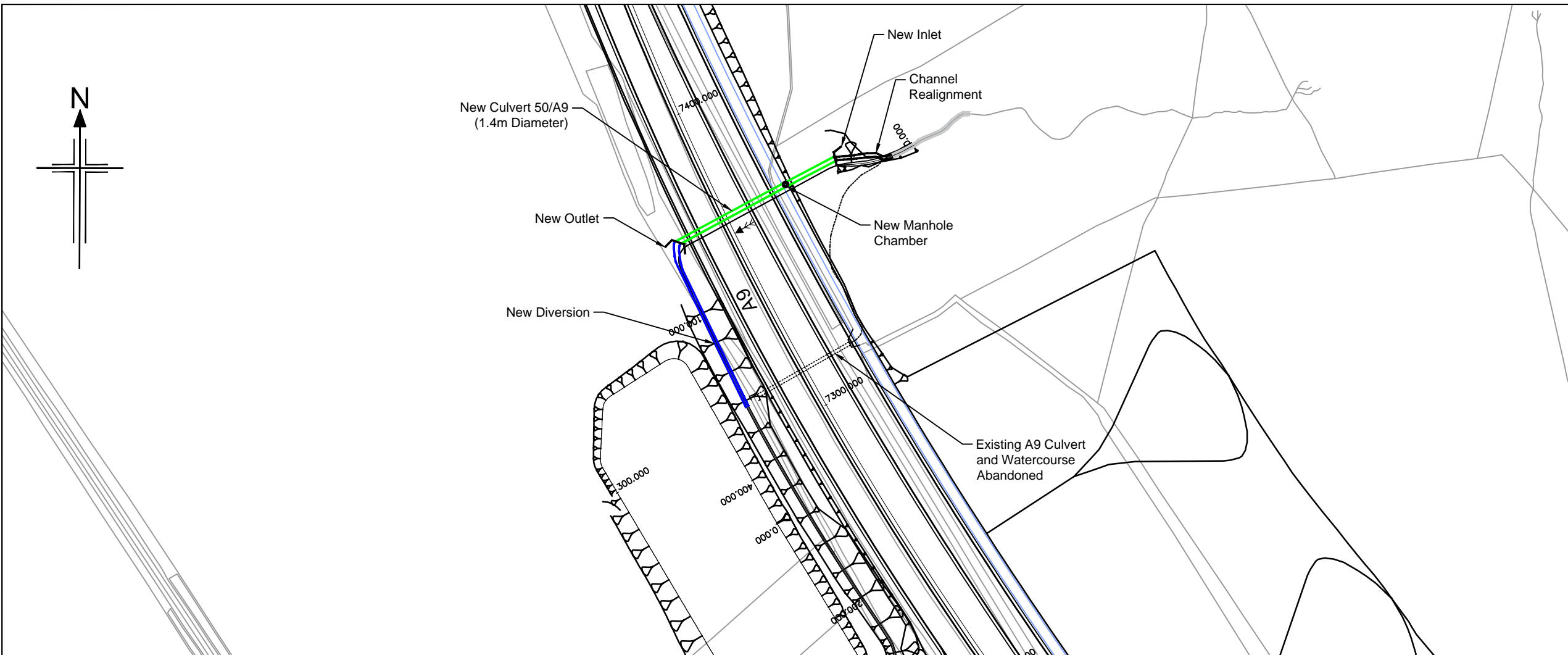

- Legend:
- New culvert/extension
 - - - Retained culvert
 - Realigned/regraded channel
 - Cascade
 - Inlet/outlet headwall (new)
 - Inlet/outlet headwall (retained)
 - Pre-earthworks drain and outfall
 - Access chamber
 - Flow direction
 - IL

- Notes:
1. All dimensions are in meters unless noted otherwise.
 2. All levels are in meters above ordnance datum.
 3. All details shown on this drawing are indicative only and subject to further development at specimen design stage. NOT FOR CONSTRUCTION.
 4. This drawing shall be read in conjunction with the 'Watercourse Crossing report' only and not in isolation.
 5. All 'new' and 'extended' culverts have been designed in accordance with the relevant provisions of DMRB.
 6. Where required 'scour protection measures' shall be provided within the zone of scour influence as indicated on the drawing. The nature and the extent of the scour protection measure will be further developed at specimen design stage in accordance with the relevant provisions of DMRB and relevant Good Practice Guides, taking into account flow hydraulics, channel geometry and channel morphology. This may include the provision of scour pools / stilling basin appropriately designed on a site by site basis.
 7. Where shown culverts shall be 'embedded' with natural river deposits to the depth shown.
 8. Where shown 'cascades' are required to safely convey the design flood event (0.5% AEP (200-year) plus allowance for climate change). The cascade geometry shown on the drawing is indicative only and will be subject to further development at specimen design stage. The nature of the cascade will take one of the following general forms:
 - Bedrock channel cascade.
 - Natural cascade with natural gravels, cobbles and rock forming individual steps.
 - Concrete cascade with stone pitching.
 The nature of the cascade will be determined at the specimen design stage taking into account hydraulic requirements, topography and nature of the underlying strata and its susceptibility to fluvial erosion.
 9. Where shown mammal ledges will be provided within the culvert in accordance with the relevant provisions of DMRB.

SCHEMATIC PLAN

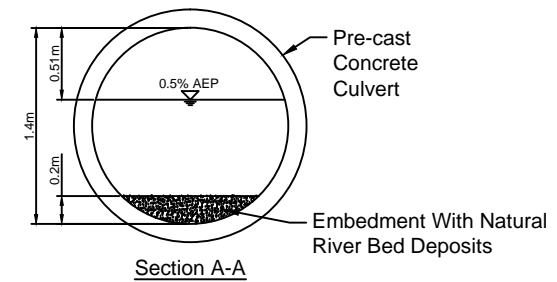

Section A-A

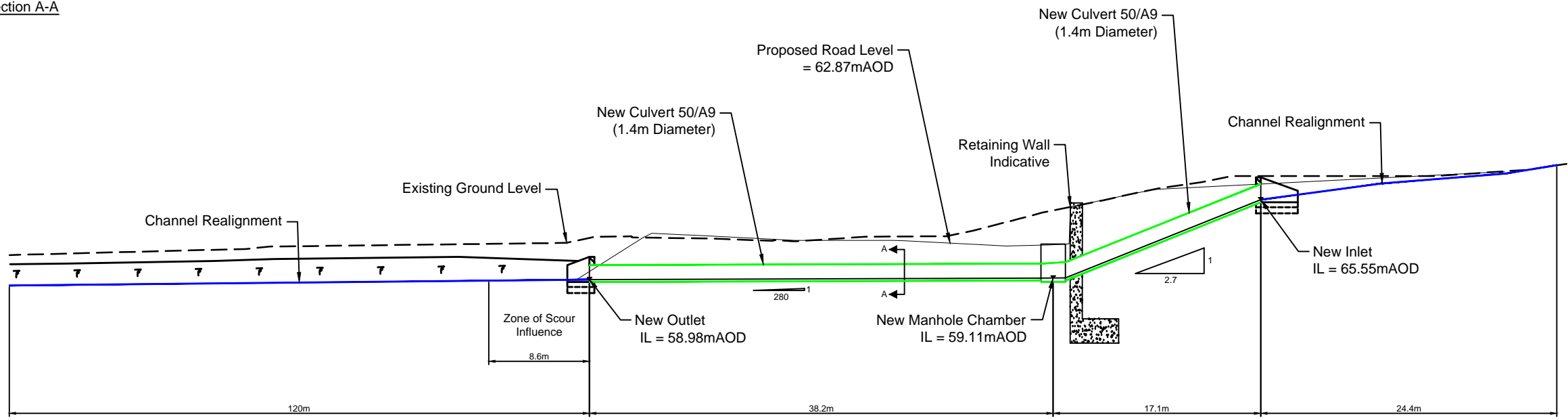

WATERCOURSE 50 LONGSECTION

| 0 | 29/01/2018 | FOR INFORMATION | KL | KA | LMCG | |
|-----|------------|---------------------|-------|---------|-------|--------|
| Rev | Rev. Date | Purpose of revision | Drawn | Checked | Rev'd | Appr'd |



Drawing title
TAY CROSSING TO BALLINLUIG PROPOSED MODIFICATIONS TO CULVERT ON WATERCOURSE WF50

Drawing status
FOR INFORMATION

Scale
 NTS @ A1 DO NOT SCALE

Jacobs No.
 B2140003

Drawing number
Figure A11.8.26

Rev
 0

Reproduced by permission of Ordnance Survey on behalf of HMSO. © Crown copyright and database right 2017. All rights reserved. Ordnance Survey Licence number 100046668.

© Copyright 2015 Jacobs U.K. Limited. This concepts and information contained in this document are the property of Jacobs. Use or copying of this document in whole or in part without the written permission of Jacobs constitutes an infringement of copyright. Limitation: This drawing has been prepared on behalf of, and for the exclusive use of, Jacobs' Client, and is subject to, and issued in accordance with, the provisions of the contract between Jacobs and the Client. Jacobs accepts no liability or responsibility whatsoever for, or in respect of, any use of, or reliance upon, this drawing by any third party.

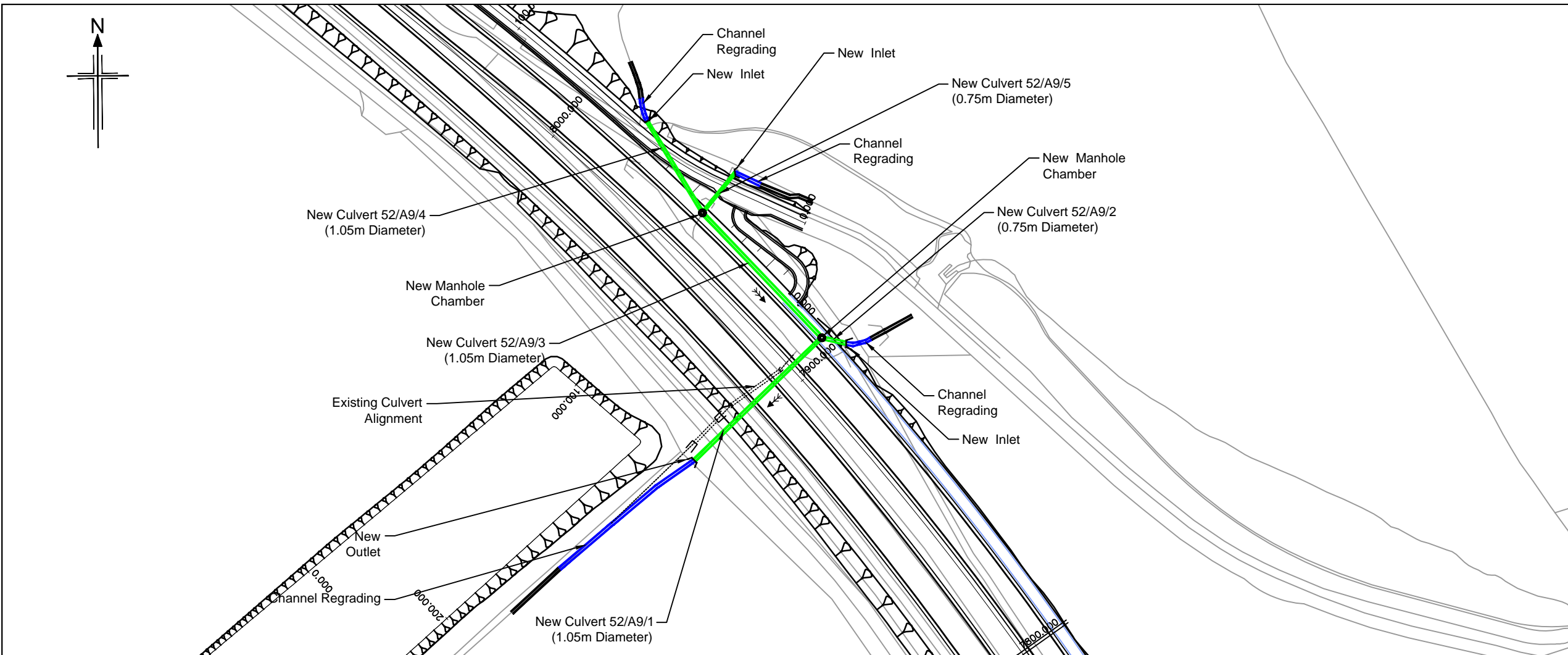

- Legend:
- New culvert/extension
 - - - Retained culvert
 - Realigned/regraded channel
 - Cascade
 -
 -
 -
 -
 -
 - IL Invert Level

- Notes:
1. All dimensions are in meters unless noted otherwise.
 2. All levels are in meters above ordnance datum.
 3. All details shown on this drawing are indicative only and subject to further development at specimen design stage. NOT FOR CONSTRUCTION.
 4. This drawing shall be read in conjunction with the 'Watercourse Crossing report' only and not in isolation.
 5. All 'new' and 'extended' culverts have been designed in accordance with the relevant provisions of DMRB.
 6. Where required 'scour protection measures' shall be provided within the zone of scour influence as indicated on the drawing. The nature and the extent of the scour protection measure will be further developed at specimen design stage in accordance with the relevant provisions of DMRB and relevant Good Practice Guides, taking into account flow hydraulics, channel geometry and channel morphology. This may include the provision of scour pools / stilling basin appropriately designed on a site by site basis.
 7. Where shown culverts shall be 'embedded' with natural river deposits to the depth shown.
 8. Where shown 'cascades' are required to safely convey the design flood event (0.5% AEP (200-year) plus allowance for climate change). The cascade geometry shown on the drawing is indicative only and will be subject to further development at specimen design stage. The nature of the cascade will take one of the following general forms:
 - Bedrock channel cascade.
 - Natural cascade with natural gravels, cobbles and rock forming individual steps.
 - Concrete cascade with stone pitching.
 The nature of the cascade will be determined at the specimen design stage taking into account hydraulic requirements, topography and nature of the underlying strata and its susceptibility to fluvial erosion.
 9. Where shown mammal ledges will be provided within the culvert in accordance with the relevant provisions of DMRB.

SCHEMATIC PLAN

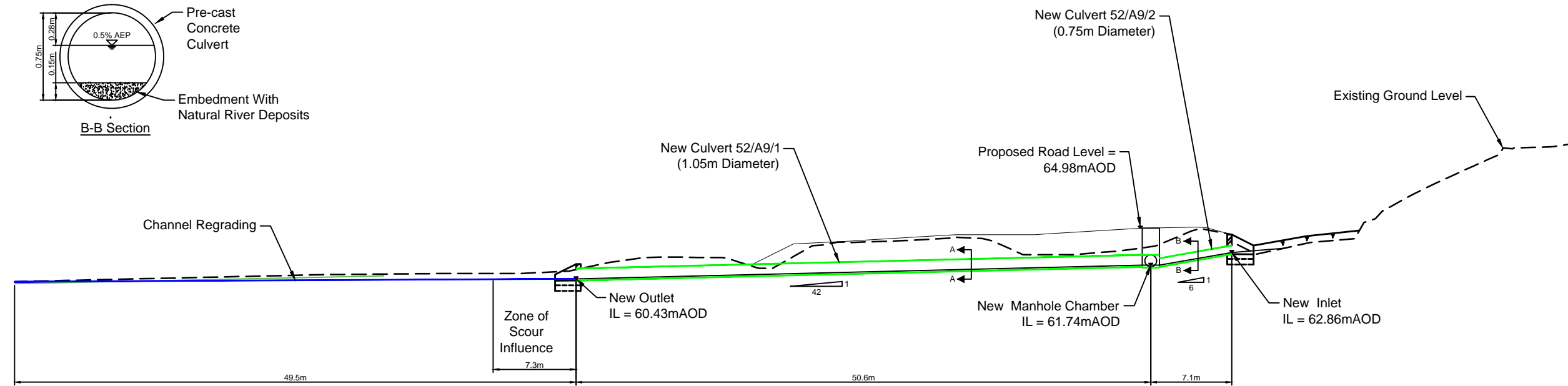
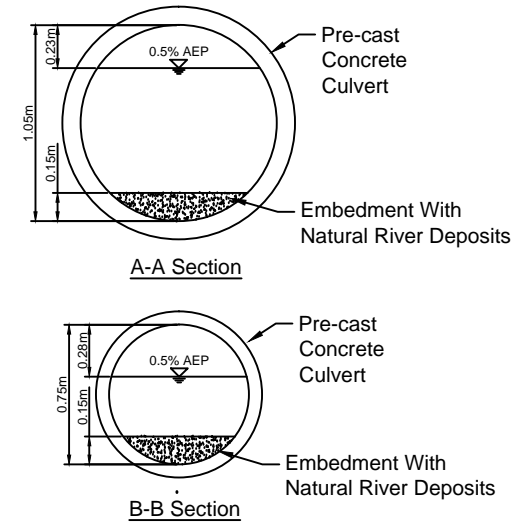

WATERCOURSE 52 LONGSECTION 1

| 0 | 29/01/2018 | FOR INFORMATION | KL | KA | LMGG | |
|-----|------------|---------------------|-------|---------|-------|---------|
| Rev | Rev. Date | Purpose of revision | Drawn | Checked | Rev'd | Apprv'd |



95 Bothwell St, Glasgow, G2 7HX
Tel: +44(0)141 243 8000 Fax: +44(0)141 226 3109
www.jacobs.com



Drawing title
TAY CROSSING TO BALLINLUIG PROPOSED MODIFICATIONS TO CULVERT ON WATERCOURSE WF52/1

Drawing status
FOR INFORMATION

Scale
NTS @ A1 **DO NOT SCALE**

Jacobs No.
B2140003

Drawing number
Figure A11.8.27

Rev
0

Reproduced by permission of Ordnance Survey on behalf of HMSO. © Crown copyright and database right 2017. All rights reserved. Ordnance Survey Licence number 100046668.

© Copyright 2018 Jacobs U.K. Limited. The concepts and information contained in this document are the property of Jacobs. Use or copying of this document in whole or in part without the written permission of Jacobs constitutes an infringement of copyright. Limitation: This drawing has been prepared on behalf of, and for the exclusive use of, Jacobs' Client, and is subject to, and issued in accordance with, the provisions of the contract between Jacobs and the Client. Jacobs accepts no liability or responsibility whatsoever for, or in respect of, any use of, or reliance upon, this drawing by any third party.

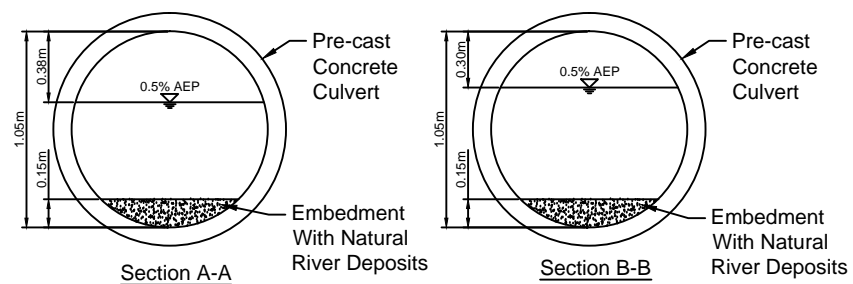

- Legend:
- New culvert/extension
 - - - Retained culvert
 - Realigned/reggraded channel
 - Cascade
 - Inlet/outlet headwall (new)
 - Inlet/outlet headwall (retained)
 - Pre-earthworks drain and outfall
 - Access chamber
 - Flow direction
 - IL Invert Level

- Notes:
1. All dimensions are in meters unless noted otherwise.
 2. All levels are in meters above ordnance datum.
 3. All details shown on this drawing are indicative only and subject to further development at specimen design stage. NOT FOR CONSTRUCTION.
 4. This drawing shall be read in conjunction with the 'Watercourse Crossing report' only and not in isolation.
 5. All 'new' and 'extended' culverts have been designed in accordance with the relevant provisions of DMRB.
 6. Where required 'scour protection measures' shall be provided within the zone of scour influence as indicated on the drawing. The nature and the extent of the scour protection measure will be further developed at specimen design stage in accordance with the relevant provisions of DMRB and relevant Good Practice Guides, taking into account flow hydraulics, channel geometry and channel morphology. This may include the provision of scour pools / stilling basin appropriately designed on a site by site basis.
 7. Where shown culverts shall be 'embedded' with natural river deposits to the depth shown.
 8. Where shown 'cascades' are required to safely convey the design flood event (0.5% AEP (200-year) plus allowance for climate change). The cascade geometry shown on the drawing is indicative only and will be subject to further development at specimen design stage. The nature of the cascade will take one of the following general forms:
 - Bedrock channel cascade.
 - Natural cascade with natural gravels, cobbles and rock forming individual steps.
 - Concrete cascade with stone pitching.
 The nature of the cascade will be determined at the specimen design stage taking into account hydraulic requirements, topography and nature of the underlying strata and its susceptibility to fluvial erosion.
 9. Where shown mammal ledges will be provided within the culvert in accordance with the relevant provisions of DMRB.

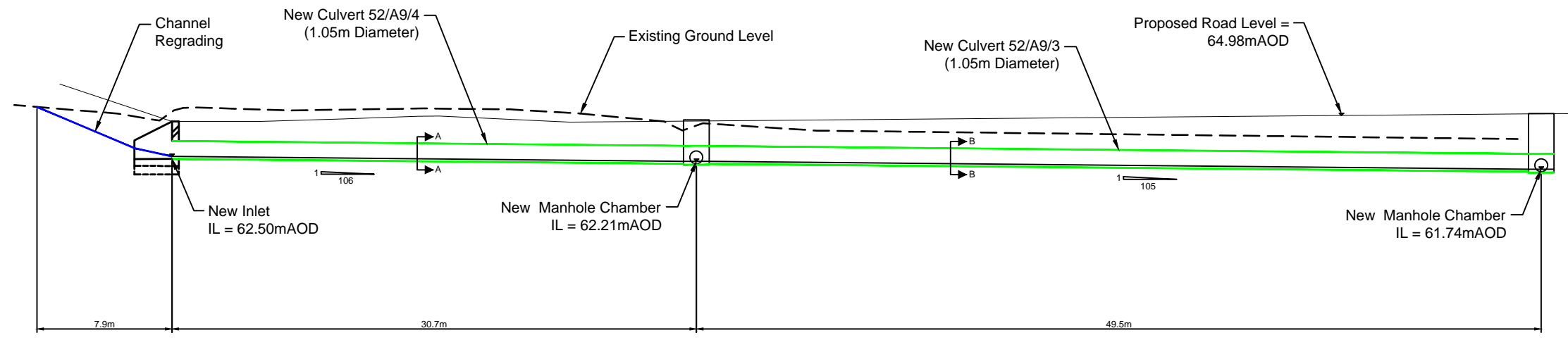

WATERCOURSE 52 LONGSECTION 2

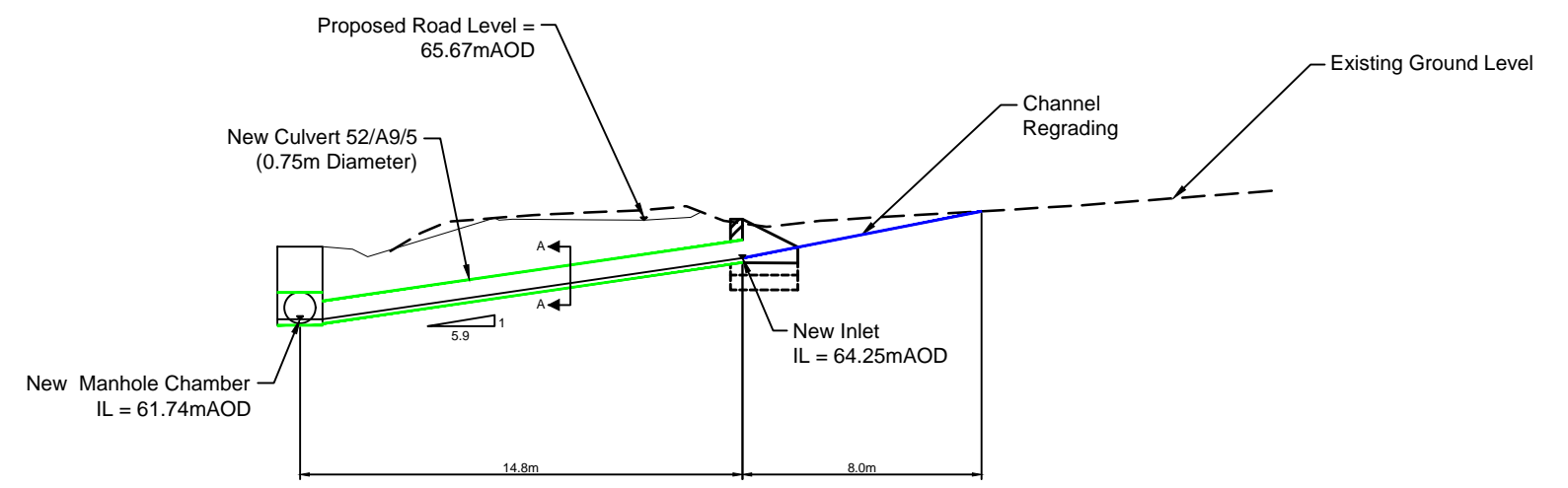
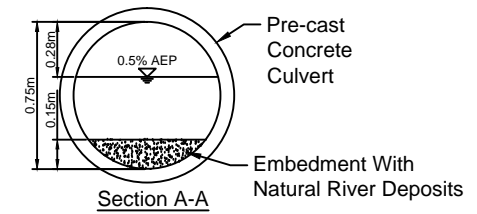

WATERCOURSE 52 LONGSECTION 3

| Rev | Rev. Date | Purpose of revision | Drawn | Checked | Rev'd | Apprv'd |
|-----|-----------|---------------------|-------|---------|-------|---------|
| 0 | 01/11/17 | FOR INFORMATION | KL | KA | LMCG | |



Drawing title
**TAY CROSSING TO BALLINLUIG
 PROPOSED MODIFICATIONS
 TO CULVERT ON
 WATERCOURSE WF52/2**

Drawing status
FOR INFORMATION

Scale: NTS @ A1 DO NOT SCALE
 Jacobs No.: B2140003

Drawing number: **Figure A11.8.28** Rev: **0**

Reproduced by permission of Ordnance Survey on behalf of HMSO. © Crown copyright and database right 2017. All rights reserved. Ordnance Survey Licence number 100046668.

© Copyright 2015 Jacobs U.K. Limited. The concepts and information contained in this document are the property of Jacobs. Use or copying of this document in whole or in part without the written permission of Jacobs constitutes an infringement of copyright. Limitation: This drawing has been prepared on behalf of, and for the exclusive use of, Jacobs' Client, and is subject to, and issued in accordance with, the provisions of the contract between Jacobs and the Client. Jacobs accepts no liability or responsibility whatsoever for, or in respect of, any use of, or reliance upon, this drawing by any third party.

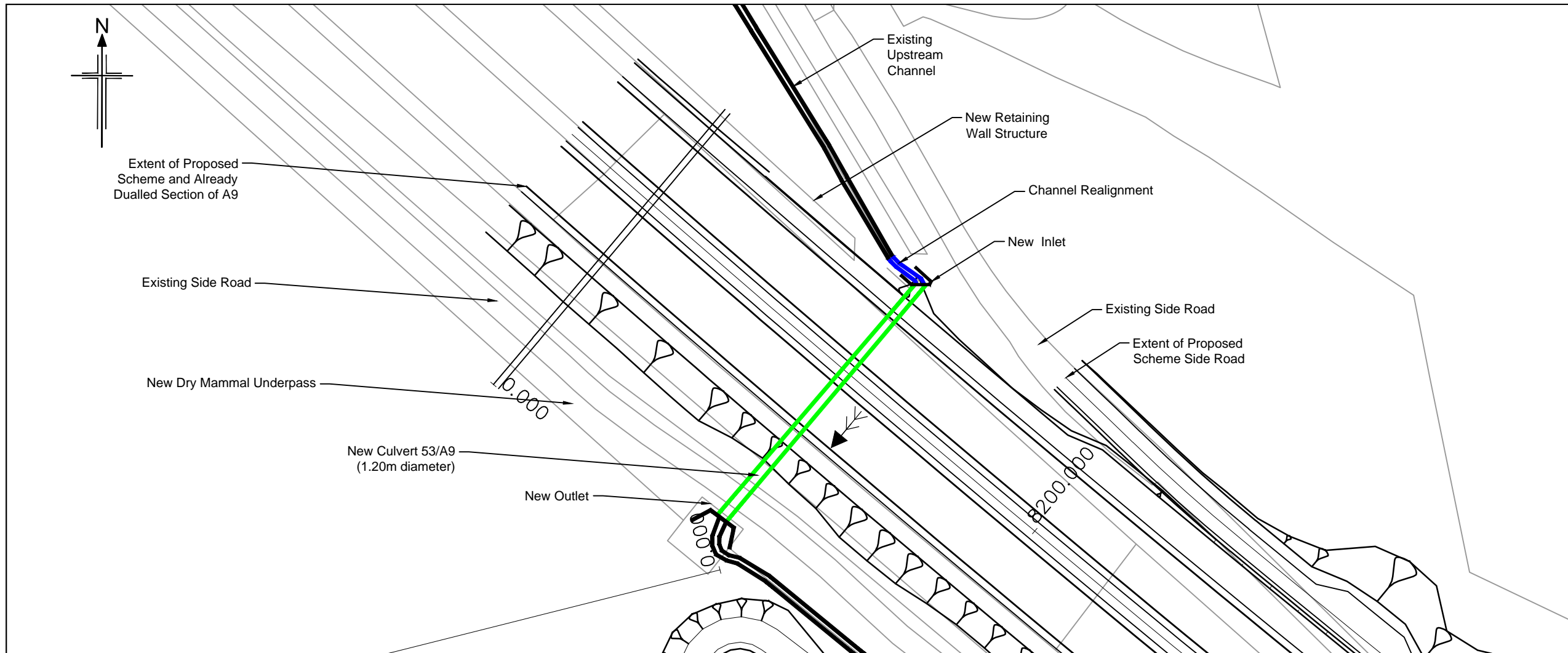

- Legend:
- New culvert/extension
 - - - Retained culvert
 - Realigned/regraded channel
 - Cascade
 - Inlet/outlet headwall (new)
 - - - Inlet/outlet headwall (retained)
 - Pre-earthworks drain and outfall
 - Access chamber
 - ← Flow direction
 - IL Invert Level

- Notes:
1. All dimensions are in meters unless noted otherwise.
 2. All levels are in meters above ordnance datum.
 3. All details shown on this drawing are indicative only and subject to further development at specimen design stage. NOT FOR CONSTRUCTION.
 4. This drawing shall be read in conjunction with the 'Watercourse Crossing report' only and not in isolation.
 5. All 'new' and 'extended' culverts have been designed in accordance with the relevant provisions of DMRB.
 6. Where required 'scour protection measures' shall be provided within the zone of scour influence as indicated on the drawing. The nature and the extent of the scour protection measure will be further developed at specimen design stage in accordance with the relevant provisions of DMRB and relevant Good Practice Guides, taking into account flow hydraulics, channel geometry and channel morphology. This may include the provision of scour pools / stilling basin appropriately designed on a site by site basis.
 7. Where shown culverts shall be 'embedded' with natural river deposits to the depth shown.
 8. Where shown 'cascades' are required to safely convey the design flood event (0.5% AEP (200-year) plus allowance for climate change). The cascade geometry shown on the drawing is indicative only and will be subject to further development at specimen design stage. The nature of the cascade will take one of the following general forms:
 - Bedrock channel cascade.
 - Natural cascade with natural gravels, cobbles and rock forming individual steps.
 - Concrete cascade with stone pitching.
 The nature of the cascade will be determined at the specimen design stage taking into account hydraulic requirements, topography and nature of the underlying strata and its susceptibility to fluvial erosion.
 9. Where shown mammal ledges will be provided within the culvert in accordance with the relevant provisions of DMRB.

SCHMATIC PLAN

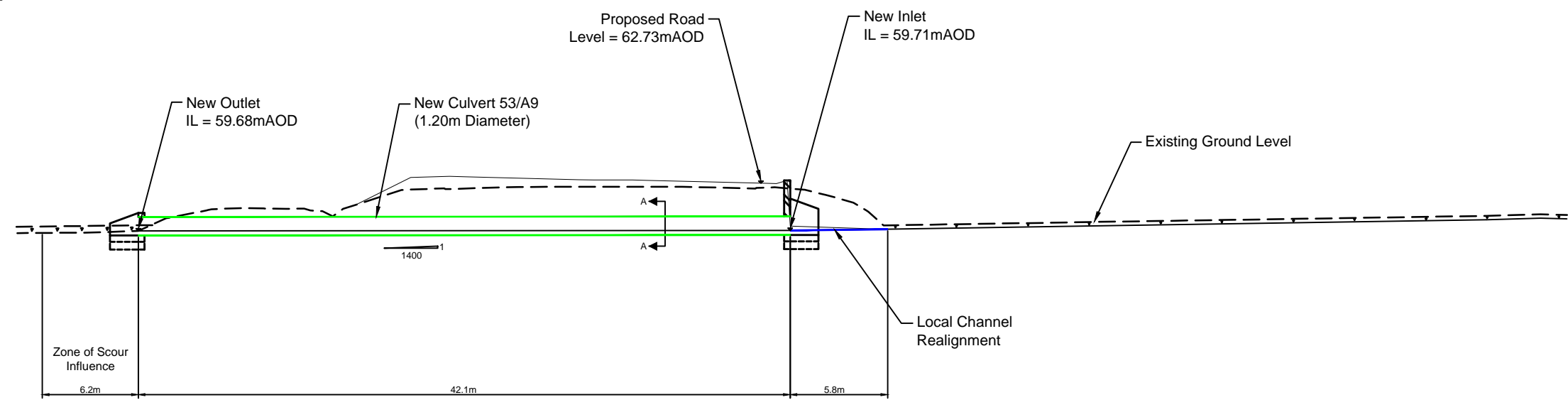
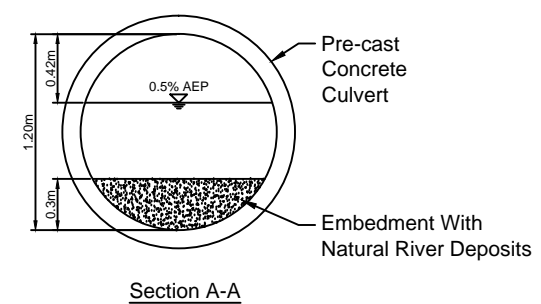

WATERCOURSE 53 LONGSECTION

Reproduced by permission of Ordnance Survey on behalf of HMSO. © Crown copyright and database right 2017. All rights reserved. Ordnance Survey Licence number 100046668.

| 0 | 26/03/2018 | FOR INFORMATION | KL | KA | LMG | |
|-----|------------|---------------------|-------|---------|-------|---------|
| Rev | Rev. Date | Purpose of revision | Drawn | Checked | Rev'd | Apprv'd |

JACOBS
 85 Bothwell St, Glasgow, G2 7HX
 Tel: +44(0)141 243 8000 Fax: +44(0)141 226 3109
 www.jacobs.com



Drawing title
**TAY CROSSING TO BALLINLUIG
 PROPOSED MODIFICATIONS
 TO CULVERT ON
 WATERCOURSE WF53**

Drawing status
FOR INFORMATION

Scale
 NTS @ A1 DO NOT SCALE

Jacobs No. B2140003

Drawing number
Figure A11.8.29 Rev 0

© Copyright 2015 Jacobs U.K. Limited. The concepts and information contained in this document are the property of Jacobs. Use or copying of this document in whole or in part without the written permission of Jacobs constitutes an infringement of copyright. Limitation: This drawing has been prepared on behalf of, and for the exclusive use of, the Client, and is subject to, and issued in accordance with, the provisions of the contract between Jacobs and the Client. Jacobs accepts no liability or responsibility whatsoever for, or in respect of, any use of, or reliance upon, this drawing by any third party.